



# CAMPEONATO RALLY ARGENTINO 2016



FECHA

07

LIBRO DE RUTA

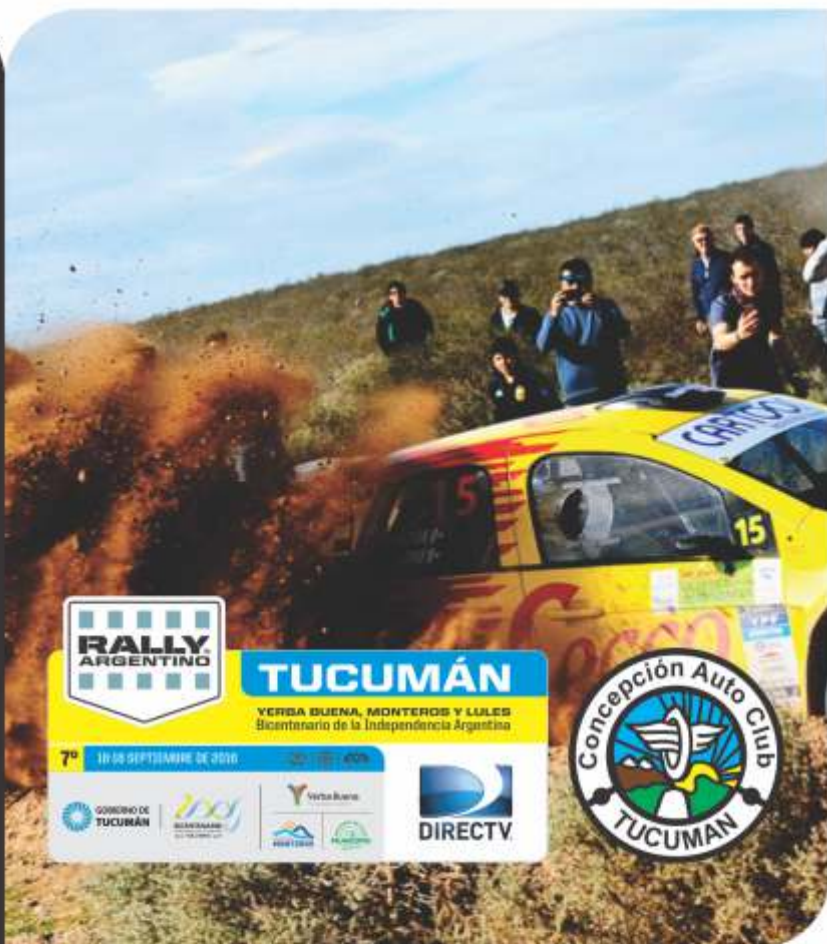

## TUCUMÁN

VEREDA BUENA, MONTE ROS Y LULES  
Bicentenario de la Independencia Argentina

7º 14-16 SEPTIEMBRE DE 2016



MAIN SPONSORS



AUTO OFICIAL



SPONSORS OFICIALES



PROVEEDORES OFICIALES





## **RALLY DE YERBA BUENA 2016 16, 17 Y 18 DE JULIO DEL 2016**

# **REGLAMENTO PARTICULAR**

## **ÍNDICE**

<b>Contenido</b>	<b>Página</b>
1. Introducción	4
1.1 Rally de Tucumán 2016	
1.2 Superficie de la Ruta	
1.3 Distancia Total de PE y del itinerario	
2. Organización	5
2.1 Títulos para los cuales el Rally es válido	
2.2 Nombre del Organizador	
2.3 Dirección y datos de contacto	
2.4 Comité Organizador	
2.5 Comisarios de la Prueba	
2.6 Representantes de ACRA	
2.7 Oficiales del Rally	
2.8 Ubicación y datos de contacto de los Cuarteles Generales	
3. Programa	7
4. Inscripciones	10
4.1 Apertura de inscripciones	
4.2 Fecha de cierre de inscripciones	
4.3 Procedimiento de Inscripción	
4.4 Número de inscriptos aceptados y clases	
4.5 Cobertura médica	



5. Seguro	12
5.1 Descripción de la cobertura de seguro	
6. Publicidad e Identificaciones	13
6.1 Placas de Rally y números de competición	
6.2 Publicidad del Organizador	
7. Neumáticos	13
7.1 Campeonato Argentino	
7.1.1 Máximo de cubiertas	
8. Combustible	14
9. Reconocimiento	14
9.1 Procedimiento de registro	
9.2 Obligaciones	
9.3 Restricciones	
9.4 Sanciones	
10. Verificación Administrativa	16
10.1 Documentos a ser presentados	
10.2 Horarios	
11. Verificación Técnica, Sellado y Marcado	16
11.1 Lugar y horarios	
11.2 Barreros	
11.3 Ventanillas polarizadas	
11.4 Equipamiento de los pilotos	
11.5 Nivel de ruido	
11.6 Preparación de motores para el sellado del bloque del motor	



12. Parque de Servicios – Reabastecimientos	18
12.1 Ubicación y Restricciones	
12.2 Reabastecimiento	
13. Otros Procedimientos	18
13.1 Procedimiento de largada promocional	
13.2 Largada Efectiva	
13.3 Procedimiento de llegada	
13.4 Chequeo adelantado permitido	
13.5 Horario oficial	
13.6 Reingresos para la etapa 2	
13.7 Ensayos (Shakedown)	
13.8 Chicanas / Desvíos	
14. Premios	21
14.1 Listado de copas	
15. Verificación técnica final – Protestas	2
15.1 Verificación técnica final	
15.2 Aranceles para formular una protesta	
15.3 Montos de apelación	
Anexo 1 - Itinerario y mapa	23
Anexo 2 - Cronograma de Reconocimiento	28
Anexo 3 - Números de Competición y Publicidad	29
Anexo 4 - Mapas de Seguridad y Centro de Atenciones	30



## 1. INTRODUCCIÓN

**1.1 El Rally de Yerba Buena 2016** se disputará de conformidad con el Código Deportivo Internacional (CDI) y sus anexos, el Reglamento Deportivo Automovilístico (RDA) de la República Argentina y sus anexos, el del Campeonato Argentino de Rally, y este reglamento particular.

Las modificaciones, correcciones y/o cambios a este Reglamento Particular serán anunciadas sólo mediante boletines fechados y numerados (emitidos por el organizador o por los Comisarios).

El Reglamento Deportivo del Campeonato Argentino de Rally en: [www.rallyargentino.com](http://www.rallyargentino.com)

### 1.2 Superficie de la Ruta

El rally será disputado sobre ripio y Asfalto.

### 1.3 Distancia total de PE y del itinerario

Distancia de PE: 125.08 Km.

Distancia Total: 387.01 Km.



## 2. ORGANIZACIÓN

### 2.1 Títulos para los cuales el Rally es válido

Campeonato Argentino de Rally para Pilotos por clases  
Campeonato Argentino de Rally para Co-Pilotos por clases  
Copa Maxi Rally (no prioritarios)

### 2.2 Nombre del Organizador

Asociación Civil Crono Argentino y Auto Club Concepción de Tucumán

### 2.3 Dirección y datos de contacto

#### En Buenos Aires

Automóvil Club Argentino

Av. del Libertador 1850.

1425. Buenos Aires, Argentina.

TEL: ++ 54 11 4808 4249. Fax: ++ 54 11 4808 4599

Email: [cdarally@aca.org.ar](mailto:cdarally@aca.org.ar)

#### Rally Argentino

[www.rallyargentino.com](http://www.rallyargentino.com)

### 2.4 Comité Organizador

GOBERNACION:

GOBERNADOR:

VICEGOBERNADOR:

MINISTRO DEL INTERIOR:

MINISTRO DE GOB., JUST. Y SEG.:

MINISTRA DE SALUD PUBLICA:

MINISTRO DE EDUCACION:

MINISTRO DE TURISMO:

SECRETARIO DE DEPORTES:

JUAN LUIS MANZUR

OSVALDO JALDO

MIGUEL A. ACEVEDO

REGINO NESTOR AMADO

ROSSANA ELENA CHAHLA

JUAN PABLO LICHTMAJER

SEBASTIAN GIOBELLINA

JOSE RENE BANEGAS



## 2.5 Comisarios de la Prueba

Pte. Colegio de Comisarios	Sr. Alejandro Muzzín	CDA
Comisario Deportivo	Sr. Daniel Stillo	CDA
Observador Deportivo	Sr. Claudio Santi	CDA

## 2.6 Representantes ACRA

Presidente:	Sr. Luis Minelli
Responsable Deportivo:	Sr. José María Volta

## 2.7 Oficiales del Rally

Director de la Prueba:	Sr. Hugo Gavilán.
Director de la Prueba Adjunto:	Sr Ricardo Kember
Responsable de Seguridad:	Crio. Insp. Jorge A. Diaz
Comisarios Técnicos (CDA):	Sr. Nicolas Caputo Sr. Juan Casajus
Responsable de Sanidad:	Sr. Cristian Ruleman
Responsables de Prensa	Sr. Miguel Mattos (Rally Argentino)
Encargados de Relaciones con los Concurrentes.	Srta. Valeria Mariani
Responsables de Resultados	Sr. Hugo Gavilan
Delegado Administrativo (CDA)	Sr. Orlando Merolla

## 2.8 Ubicación y datos de contacto de los Cuarteles Generales:

Predio de esquina Av Pte Perón y Bascary Norte



### 3. PROGRAMA

#### **Lunes 05 de Septiembre**

20:00 hs.

#### **Apertura de inscripciones**

Rally Argentino

[www.rallyargentino.org/intra/sad](http://www.rallyargentino.org/intra/sad)

CDA - ACA. Avda. del Libertador 1850 -  
Buenos Aires

Tel/FAX (54) (11) 4808-4599

e-mail: [cdarally@aca.org.ar](mailto:cdarally@aca.org.ar)

#### **Viernes 09 de Septiembre**

20.00 hs.

#### **Cierre de inscripciones Final**

#### **Martes 13 de Septiembre**

18.00 hs.

#### **Publicación del Listado de Inscriptos**

#### **Miércoles 14 de Septiembre**

09:00 hs.

#### **Apertura Parque de Servicio**

#### **Jueves 15 de Septiembre**

14:00 a 15:00 hs.

#### **Entrega de Libros de Ruta**

Parque de Servicio

Yerba Buena

16:00 a 19:00 hs.

#### **Período de reconocimiento de rutas**

Según cronograma en libro de ruta

18:00 a 20:00 hs.

#### **Verificación Administrativa**

Parque de Servicio

Yerba Buena





## **Viernes 16 de Septiembre**

- 08:00 a 18:00 hs. **Período de reconocimiento de rutas**  
Según cronograma en libro de ruta
- 08:00 a 12:00 hs. **Verificación Técnica**  
Estación de Servicio Refinor  
Magallanes 1931 - Yerba Buena
- 08:00 a 10:00 hs. **Clase RC5- Junior**  
**Clase RC2N / Maxi Rally**
- 10:00 a 10:40 hs. Equipos: Tango – QTR - Nicolas
- 10:40 a 11:20 hs. Equipos: Baratec - Castrol
- 11:20 a 12:00 hs. Equipos: VRT - CGR
- 12:00 a 12:30 hs. **Autos Observados**
- 14:00 a 17:00 hs. **Shakedown**  
Predio La Hoya
- 14:00 a 15:00 hs. Clase RC5
- 15:00 a 16:00 hs. Clase Junior – RC2N
- 16:00 a 17:00 hs. Maxi Rally
- 17:00 hs. **Reunión Comisarios Deportivos**
- 18:00 hs. **Publicación de Tripulaciones Habilitadas para Largar y Orden de Larg. Sección 1**
- 18:30 a 19:30 hs. **Parque de Largada Promocional**
- 20:00 hs. **Sesión de autógrafos**



20:30 hs

## **Elección Orden de Partida Día 1**

21:00 hs.

## **Largada Promocional**

Rampa de Largada

Plaza Independencia – Tucumán Capital

## **Sábado 17 de Septiembre**

09:30 hs.

## **Largada Día 1 – CH 0**

Parque de Servicio

Yerba Buena

18:30 hs.

## **Conferencia de Prensa**

Concurren los tres primeros ubicados en la  
Clasificación General

18:00 hs.

## **Publicación Orden de Largada**

Día 2 – Sección 3

## **Domingo 18 de Septiembre**

08:30 hs.

## **Largada Día 2**

Ch 6E – Salida Parque Cerrado

12:06 hs

## **Ingreso al Parque Cerrado**

13:00 hs.

## **Verificación Técnica Final**

Estación de Servicio Refinor

Magallanes 1931 - Yerba Buena

14:00 hs

## **Entrega de Premios**

15:00 hs.

## **Publicación de la Clasificación Final provisoria**



## 4. INSCRIPCIONES

### 4.1 Apertura de Inscripciones

La apertura de inscripciones se producirá el Lunes 5 de Septiembre de 2016 a las 20:00 hs

### 4.2 Fecha de cierre de inscripciones

Las inscripciones cierran el Viernes 09 de Septiembre del 2016 a las 20:00 hs.

### 4.3 Procedimiento de inscripción

Cualquier persona que desee participar del Rally de Yerba Buena puede hacerlo enviando fax o e mail a las siguientes direcciones:

Automóvil Club Argentino: Fax 54 11 48084599  
e-mail [cdarally@aca.com.ar](mailto:cdarally@aca.com.ar)  
Rally Argentino [www.rallyargentino.com](http://www.rallyargentino.com)

### 4.4 Número de inscriptos aceptados y clases

En el Rally de Yerba Buena no se considera un número máximo de inscriptos.

Las clases estarán divididas en conformidad con el Art. 4.1.1 del Reglamento Deportivo del Campeonato Argentino de Rally.

#### 4.4.1 Campeonato Argentino de Rally

Clases	Grupos	
Maxi Rally (RC2)	Maxi Rally	<b>Nota 1</b>
RC2N	Grupo N autos sobre 2000cc (ex N4 Light)	<b>Nota 2</b>
Junior (RC3)	Junior	<b>Nota 1</b>
RC5	Grupo N autos sobre 1400 cc y hasta 1600cc	<b>Nota 3</b>

**Nota 1:** Autos Maxi Rally (RC2) y Junior (RC3) homologación ADN (CDA) desarrollada sobre bases técnicas equivalentes a los requisitos de la FIA. Estándares de seguridad según el artículo 253 del anexo J del CDI vigente.

**Nota 2:** Los modelos y características técnicas de los autos autorizados en esta clase, están definidos en el Reglamento Técnico de la categoría

**Nota 3:** En la clase RC5 son admitidos solamente autos Grupo N, homologación CDA

#### 4.5 Cobertura Médica

La cobertura médica, seguro por accidentes y seguro de vida, para todos los participantes, pilotos y navegantes, será cubierta por la Asociación Argentina de Volantes.

Para Campeonato Argentino el valor de la cobertura por tripulación será de pesos argentinos \$ 2.400 y deberá ser abonado en el momento de la verificación administrativa.

## 5. SEGURO

### 5.1 Descripción de la cobertura de seguro

Los derechos de inscripción incluyen una prima de seguro contratada con Río Uruguay Seguros, en vigencia del 16 al 18 de Septiembre del 2016, que cubre lo siguiente:

1. Incendio: Mientras estén estacionados en los parques cerrados, los autos participantes y sus accesorios estarán cubiertos contra incendio, explosión, malevolencia, vandalismo, tumulto y actos de terrorismo, según el vehículo y hasta \$ 3.380.000.
2. Daños: Mientras estén en el parque de asistencia, áreas de reabastecimiento, de reagrupamiento y de verificación técnica, los autos participantes estarán cubiertos por el seguro del organizador.
3. Responsabilidad Civil: Límites de sumas aseguradas por la responsabilidad civil extracontractual a espectadores e invitados
  - . Lesiones y/o muertes de personas hasta \$ 2.000.000 (pesos dos millones) cada una y \$ 5.000.000 (pesos cinco millones) por acontecimiento.
  - . Daños a cosas de terceros (daños materiales) hasta \$ 1.500.000 (pesos un millón quinientos mil)
4. El Comité Organizador declina toda responsabilidad respecto a las consecuencias causadas por la violación de leyes, reglas u ordenanzas cometidas por los competidores, quedando dichas consecuencias bajo la única responsabilidad de aquellos quienes cometieron la acción.

5. Bajo ningún aspecto se considerarán como participantes oficiales en la carrera a los vehículos de servicio, incluso aquellos portando placas especiales con la identificación **“ASISTENCIA”** emitidas por el organizador. Por lo tanto no están cubiertos por la póliza de seguro del rally y quedan bajo la sola responsabilidad de sus propietarios.

Lo mismo es válido para los autos utilizados por los competidores durante el reconocimiento, incluso cuando porten un número de serie o una calcomanía específica del evento.

## 6. PUBLICIDAD E IDENTIFICACIÓN

### 6.1 Placas de rally y números de competición.

Ver Anexo 3

### 6.2 Publicidad del Organizador

La publicidad del organizador será descripta en un Boletín.

Los números de competición, placas de rally y publicidad deberán estar adheridos al auto antes de la verificación técnica.

## 7. NEUMÁTICOS

Se deberán respetar las especificaciones, restricciones y obligaciones del Reglamento Deportivo

### 7.1 Campeonato Argentino

Según Art. 49 - Los neumáticos a utilizar en todas las clases serán provistos por la Asociación Civil Rally Argentino.



En cada prueba ACRA informará a las autoridades, las características de las cubiertas a utilizar en cada clase

### **7.1.1 Máximo de cubiertas**

La cantidad máxima de cubiertas a utilizar por quienes participen del Campeonato Argentino (Art. 49.2 del Reglamento Deportivo), será informada por un Boletín.

## **8. COMBUSTIBLE**

Deberán ser respetadas las especificaciones, restricciones y obligaciones del Campeonato Argentino.  
El combustible debe ser provisto por ACRA.

## **9. RECONOCIMIENTO**

### **9.1 Procedimiento de registro**

Ubicación: Parque de Servicio, Secretaría de la Prueba, Av. Pte. Perón y Buscary Norte, a partir del Jueves 15 de Septiembre a las 18:00 hs.

Antes del comienzo del reconocimiento todos los competidores deben registrarse para obtener los pases de reconocimiento. No se permitirá el acceso de los competidores a una prueba especial abierta al reconocimiento a menos que exhiban estos pases de vehículo.

### **9.2 Obligaciones**

El reconocimiento de ruta comenzará para todas las tripulaciones el día Jueves 15 de Septiembre a las 16:00 hs. y deberá ajustarse al Plan de Reconocimientos - Anexo 2.

El cumplimiento de las reglamentaciones de reconocimientos será verificado por oficiales del rally y los competidores deberán acatar

las instrucciones de estos oficiales. A efectos del registro, las tripulaciones deben ingresar al tramo por el punto de partida. Queda prohibido hacerlo por accesos intermedios.

### 9.3 Restricciones

Se prevé un máximo de dos pasadas por cada tramo cronometrado durante el reconocimiento para todas las tripulaciones inscriptas.

Durante el reconocimiento, el límite de velocidad será de 80 Km/h en las pruebas especiales, a menos que las señales de tránsito, el libro de ruta o los boletines indiquen un límite de velocidad menor.

Los competidores deben manejar de manera tal que no pongan en peligro o causen inconvenientes al tráfico habitual o a las personas que residan cerca de los tramos. Todos los competidores deben tener en cuenta que habrá controles policiales estrictos para prevenir los excesos de velocidad y otras infracciones de tránsito.

Bajo ninguna circunstancia las tripulaciones pondrán manejar en la dirección opuesta a la del rally en un tramo cronometrado.

### 9.4 Sanciones

Por exceso de velocidad se aplicarán las siguientes sanciones (art. 15.2.2 del Reglamento Deportivo).

Primera vez: Pesos Dos mil ( \$ 2.000 )

Segunda vez: penalización de 2 minutos a aplicar en el Día 1.

Tercera vez: Denegar la largada de la prueba.

Otras infracciones referidas a reconocimientos, serán informadas por el Director de la Prueba a los Comisarios Deportivos quienes podrán aplicar alguna de las sanciones consignadas en los art. 12.2 y 12.3 del CDI.





## 10. VERIFICACIÓN ADMINISTRATIVA

### 10.1 Documentos a ser presentados

En la verificación administrativa se controlarán los siguientes documentos:

Licencia del concurrente

Licencia deportiva / licencia de conducir / pasaporte o documento de los pilotos y copilotos

Autorización de la Autoridad Deportiva Nacional para todos los competidores que posean licencia emitida por otros países (no Argentina) Art. 3.9, 9.2, 9.3 y 9.4 del CDI

Información consignada en el formulario de inscripción

### 10.2 Horarios

Ubicación: Secretaría de la Prueba, Av. Pte. Perón y Buscary Norte

Horarios: Jueves 15 de Septiembre de 18:00 hs. a 20:00 hs.

## 11. VERIFICACIÓN TÉCNICA, SELLADO Y MARCADO

### 11.1 Lugar y horarios

Se realizará en el recinto acondicionado a tal efecto en la Estación de Servicio REFINOR, de Magallanes 1931 – Yerba Buena.

Se llevará a cabo a partir del Viernes 16 de Septiembre a las 08:00 hs. en los horarios establecidos en el programa de la prueba.

**11.2 Barreros** En referencia al Art. 7.7 del Art. 252 del Anexo J se autoriza el uso de barreros.

### **11.3 Ventanillas polarizadas**

El uso de vidrios polarizados, en conformidad con el Art. 11, del Art. 253 del Anexo J, está autorizado.

### **11.4 Equipamiento de los pilotos**

El equipamiento de seguridad (Anexo L del CDI de la FIA – Capítulo III) podrá ser verificado durante la verificación técnica previa y/o durante todo evento.

### **11.5 Nivel de ruido**

Se les recuerda a los competidores que de acuerdo al Art. 252 del Anexo J de la FIA, el nivel máximo de ruido permitido es 103 dB(A).

### **11.6 Preparación del motor para el sellado del block**

Un orificio perforado en el block del motor para colocar un alambre, una placa y un sello, en una posición visible para ser visto cuando se abre el capó. Además en la clase RC2N es necesario disponer de perforaciones en dos tornillos consecutivos en: Turbo compresor, Caja de velocidades, Transfer y Diferencial trasero.

### **11.7 Espirales y Amortiguadores**

En esta prueba no se permite el cambio de espirales de suspensión y amortiguadores.

Los mismos serán precintados en la verificación técnica previa, debiendo estar preparados para ello y solo podrán ser cambiados por otros de las mismas características (dimensiones, cargas, etc) con la autorización de los Comisarios Técnicos.

Respecto de los amortiguadores en especial, las características y componentes interiores de los que se colocan, deben ser iguales a las de los que se remplazan

Estas condiciones serán verificadas por los Comisarios Técnicos.

## 12. PARQUE DE SERVICIOS REABASTECIMIENTO

### 12.1 Ubicación y restricciones

El Parque de Servicios estará ubicado en Av. Pte. Perón y Buscary Norte.

Los vehículos de asistencia están autorizados a ingresar al Parque de Servicios sólo si están identificados con las placas entregadas por el organizador debidamente adheridas. Serán ubicados según las instrucciones impartidas por las autoridades del Organizador.

Podrán ingresar también los vehículos de las autoridades de la prueba y de ACRA.

No se permitirá el ingreso de vehículos no autorizados

### 12.2 Reabastecimiento

Las condiciones y procedimientos se describen en los Art. 48 de los Reglamentos Deportivos del Campeonato.

Cualquier zona de reabastecimiento debe figurar en el Itinerario del rally y en el Libro de Ruta.

No podrán entrar al sector los vehículos de asistencia.

Está prohibido el reabastecimiento de combustible en el Parque de Servicio y/o en surtidores comerciales.

## 13. OTROS PROCEDIMIENTOS

### 13.1 Presentación Largada Promocional

El día viernes 16 de Septiembre se llevará a cabo el inicio del rally de manera promocional, desde la rampa de largada ubicada en la Plaza Independencia – Tucumán Capital.

Los autos se presentarán en el Parque de Largada a partir de las 18:30 hs, podrán ser ingresados por un miembro del equipo y el horario de cierre del Parque será a las 19:30 hs. La partida de la primera tripulación desde la rampa se hará efectiva a las 21:00 hs.



### **13.2 Largada efectiva**

La largada efectiva de la prueba se producirá desde el CH0 en la Plaza de Monteros.

### **13.3 Procedimiento de llegada**

El rally terminará en el control horario CH 12A donde los autos serán ingresados a un Parque Cerrado.

Una vez que hayan arribado el total de los vehículos, se procederá a la ceremonia de premiación. Los participantes que no lo hagan, salvo casos de fuerza mayor previamente notificada y aceptada, serán informados a los Comisarios Deportivos quienes podrán aplicar una sanción.

El procedimiento de la Verificación Técnica final se ajustará a lo indicado en el Art. 15.1 de este reglamento.

Los autos pueden ser conducidos desde el Parque Cerrado a la Verificación Técnica, por un miembro del equipo.

Los autos que no que no deban concurrir a la verificación permanecerán en el Parque Cerrado hasta que los Comisarios Deportivos procedan a la liberación del mismo.

### **13.4 Chequeo adelantado permitido**

Las tripulaciones están autorizadas a realizar chequeo adelantado sin incurrir en una penalidad en los CH 6d y CH 12a.

### **13.5 Horario Oficial**

La hora de uso en la prueba corresponderá a la hora oficial de la República Argentina.

### 13.6 Reingresos para la Etapa 2

Las tripulaciones que hayan hecho abandono de la prueba durante el día 1, podrán intervenir en el día 2 de acuerdo a las siguientes condiciones.

- a. Si se han retirado de la prueba por haber excedido los tiempos máximos permitidos o que hayan reportado inconvenientes mecánicos u otros a la Dirección de Carrera. No podrán hacerlo aquellas tripulaciones que hayan sido excluidas del evento por los Comisarios Deportivos por infringir condiciones reglamentarias.

El auto y el block motor deben ser los mismos presentados en la verificación técnica inicial, pero además, en caso de ser requerido, el motor puede ser cambiado sin penalización (art.35.5.1 del Reglamento Deportivo del Campeonato Argentino)

- b. El auto podrá ser reparado a discreción pero deberá ser ingresado al parque de reagrupamiento nocturno hasta el ingreso al Parque Cerrado del último auto en carrera. Caso contrario podrá ser ingresado entre 30 minutos y una hora antes de la salida programada del primer auto de dicho reagrupamiento nocturno.
- c. Luego los Comisarios Técnicos procederán a la verificación y precintado de elementos si fuera necesario.
- d. Es responsabilidad del concurrente el traslado desde el lugar del abandono hasta el parque de Servicios.
- e. Esta participación les permite a las tripulaciones obtener puntaje en el día 2, pero no en la clasificación general.
- f. El orden de largada de estas tripulaciones será establecido por la Dirección de Carrera con el acuerdo de los Comisarios Deportivos.

### **13.7 Shakedown**

Las pruebas técnicas con los autos de competición se llevarán a cabo el viernes 1 de Septiembre a partir de las 14:00 hs. en el Predio La Hoya.

Las primeras tres pruebas (pasadas), dentro del tiempo asignado a la tanda, deberán ser realizadas por la tripulación inscripta y serán las consideradas como oficiales para el registro de tiempos. Las pasadas o pruebas restantes, o las realizadas con acompañantes invitados, no serán tenidas en cuenta para los registros oficiales.

Cualquier persona a bordo del auto durante la sesión de práctica que no haya sido inscripta para el rally, deberá haber firmado una renuncia de derechos proporcionada por el organizador.

Las personas invitadas a participar en carácter de navegantes, deberán hacerlo debidamente ajustadas a sus butacas y con el casco protector colocado. El uso del buzo ignífugo es obligatorio, (art. 24.7 del Reglamento Deportivo)

### **13.8 Chicanas / Desvíos**

La construcción de las chicanas y su control se realizara de acuerdo al art. 7.5 del Reglamento Deportivo.

Las penalizaciones para el caso en que no se respete esta norma serán:

un (1) minuto en la primera oportunidad, diez (10) minutos en la segunda y removido de la clasificación en una tercera ocasión.

El informe del veedor destacado en el lugar, será inapelable.

## **14. PREMIOS**

### **14.1 Listado de trofeos**

Se entregarán premios (1 trofeo a cada miembro de la tripulación) según la siguiente lista:



## **Clasificación General**

1° al 3° puesto

## **Clasificación por clases**

1° al 3° puesto

## **Copa Maxi Rally (no prioritarios)**

1° al 3° puesto

El organizador se reserva el derecho de entregar premios adicionales

# **15. VERIFICACIÓN TÉCNICA FINAL - PROTESTAS**

## **15.1 Verificación técnica final**

La verificación técnica final tendrá lugar en la Estación de Servicio REFINOR, de Magallanes 1931 – Yerba Buena.

Los autos sujetos a la verificación técnica final (a decisión de los Comisarios) deben tener un representante del concurrente así como mecánicos (en caso de desmantelamiento) presentes en la verificación técnica final.

## **15.2 Aranceles para formular una protesta**

Campeonato Argentino: \$ 10.000.-

## **15.3 Monto de la apelación**

Monto de la apelación ante la CDA del ACA: \$ 10.000.-

## ANEXO 1. ITINERARIO/CRONOGRAMA- MAPA

### Día 1, Sección 1

SABADO 17 DE SEPTIEMBRE DEL 2016						
C.H. P.E.	LUGAR	DIST. PE	DIST. ENLACE	DIST. TOTAL	TIEMPO OTORGADO	PASO T AUTO
0	MONTEROS - Parque de Largada (Salida)					09:30
1			5,94	5,94	00:10	09:40
	<b>PE 1 MONTEROS - MONTEROS</b>	<b>4,44</b>				<b>09:43</b>
	<b>RZ</b>					
<b>1</b>	<b>LULES (a los 42,25 del ch 1)</b>					
	Km hasta llegar al siguiente reabastecimiento	31,62	20,05	51,67		
2			45,46	49,90	01:00	10:43
	<b>PE 2 LULES - POTRERO DE LAS TABLAS</b>	<b>22,50</b>				<b>10:46</b>
3			8,56	31,06	00:40	11:26
	<b>PE 3 POTRERO DE LAS TABLAS - EL SIAMBON</b>	<b>9,12</b>				<b>11:29</b>
	<b>RZ</b>					
<b>2</b>	<b>RACO (a los 17,40 del ch 3)</b>					
	Km hasta llegar al siguiente reabastecimiento		69,62	69,62		
3A	YERBA BUENA - Parque de Servicio INGRESO		59,01	68,13	01:30	12:59
	<b>FLEXI SERVICE - MAXIMO</b>				<b>00:20</b>	
3B	Parque Servicio INGRESO					12:59
	<b>PARQUE DE SERVICIO "A" - YERBA BUENA</b>	<b>36,06</b>	<b>118,97</b>	<b>155,03</b>	<b>00:30</b>	
3C	Servicio SALIDA / Reagrupamiento INGRESO					13:29
	<b>REAGRUPAMIENTO - MAXIMO</b>				<b>00:35</b>	



## Día 1, Sección 2

INICIO (Sección 2)		SABADO 17 DE SEPTIEMBRE DEL 2016			
3D	YERBA BUENA - Parque de Servicio (Salida)				14:04
RZ	LULES				
3	(a los 19,00 del ch 3D)				
	Km hasta llegar al siguiente reabastecimiento	31,62	20,05	51,67	
4		26,65	26,65	00:35	14:39
PE 4	LULES - POTRERO DE LAS TABLAS	22,50			14:42
5		8,56	31,06	00:40	15:22
PE 5	POTRERO DE LAS TABLAS - EL SIAMBON	9,12			15:25
RZ	RACO				
4	(a los 17,40 del ch 5)				
	Km hasta llegar al siguiente reabastecimiento	1,80	51,94	53,74	
6		55,68	64,80	01:25	16:50
PE 6	SUPER ESPECIAL LA HOYA	1,80			16:53
6A	YERBA BUENA- Zona Técnica INGRESO		4,48	6,28	17:08
	ZONA TECNICA			00:10	
6B	Zona Técnica SALIDA - Flexi Service INGRESO				17:18
	FLEXI SERVICE - MAXIMO			00:45	
6C	Flexi Service SALIDA - Parque Servicio INGRESO				17:18
	PARQUE DE SERVICIO "B" - YERBA BUENA	33,42	95,37	128,79	01:00
6D	Servicio SALIDA - Parque Cerrado INGRESO				18:18
	REAGRUPAMIENTO NOCTURNO				
TOTALES SABADO		69,48	214,34	283,82	

## Día 2, Sección 3

INICIO (Sección 5)		DOMINGO 18 DE SEPTIEMBRE DEL 2016	
6E	Parque de Cerrado SALIDA - Parque de Servicio INGRESO		08:30
	PARQUE DE SERVICIO "C" - YERBA BUENA	0,00 0,00 0,00	00:25
6F	Parque de Servicio SALIDA		08:55
<b>RZ</b>			
<b>5</b>	YERBA BUENA (a los 0,06 del ch 6F)		
	Km hasta llegar al siguiente reabastecimiento	27,80 23,98 51,78	
7		11,77 11,77 00:20	09:15
<b>PE 7</b>	<b>SAN PABLO - VILLA NOUGUES</b>	<b>10,22</b>	<b>09:18</b>
8		1,04 11,26 00:15	09:33
<b>PE 8</b>	<b>VILLA NOUGUES - SAN JAVIER</b>	<b>10,78</b>	<b>09:36</b>
9		2,55 13,33 00:25	10:01
<b>PE 9</b>	<b>SAN JAVIER - YERBA BUENA</b>	<b>6,80</b>	<b>10:04</b>
9A	Yerba Buena - Parque de Servicio INGRESO	8,62 15,42 00:20	10:24
	FLEXI SERVICE - MAXIMO		00:20
9B	Parque Servicio INGRESO		10:24
	PARQUE DE SERVICIO "D" - YERBA BUENA	27,80 23,98 51,78	00:30
9C	Servicio SALIDA / Reagrupamiento INGRESO		10:54
	REAGRUPAMIENTO - MAXIMO		00:35

## Día 2, Sección 4

INICIO (Sección 6)		DOMINGO 18 DE SEPTIEMBRE DEL 2016			
9D	YERBA BUENA - Parque de Servicio (Salida)				11:29
<b>RZ</b>	<b>YERBA BUENA (a los 0,06 del ch 9D)</b>				
<b>6</b>	Km hasta llegar al siguiente reabastecimiento	27,80	23,92	51,72	
10			11,77	11,77	00:20
	<b>PE 10 SAN PABLO - VILLA NOUGUES</b>	<b>10,22</b>			<b>11:49</b>
11			1,04	11,26	00:15
	<b>PE 11 VILLA NOUGUES - SAN JAVIER</b>	<b>10,78</b>			<b>12:10</b>
12			2,55	13,33	00:25
	<b>PE 12 SAN JAVIER - YERBA BUENA</b>	<b>6,80</b>			<b>12:38</b>
12A	YERBA BUENA - Podio Final		8,62	15,42	00:20
<b>TOTALES DOMINGO</b>		<b>55,60</b>	<b>47,96</b>	<b>103,56</b>	
<b>RESUMEN DE LA COMPETENCIA</b>					
		<b>PE</b>	<b>ENLACES</b>	<b>TOTAL</b>	<b>%PE</b>
Sábado		69,48	214,19	283,67	55,5
Domingo		55,60	47,96	103,56	44,5
<b>Total del Rally</b>		<b>125,08</b>	<b>262,15</b>	<b>387,23</b>	<b>100,00</b>

## Mapa



## ANEXO 2. CRONOGRAMA DE RECONOCIMIENTOS

### JUEVES 15 DE SEPTIEMBRE:

**16:00 a 19:00 hs. (2 Pasadas)**

PE. 7/10 – San Pablo – Villa Nougues

PE. 8/11 – Villa Nougues – San Javier

PE. 9/12 – San Javier – Yerba Buena

### VIERNES 16 DE SEPTIEMBRE

**08:30 a 18:00 hs. (2 Pasadas)**

PE. 1 – Monteros - Monteros

PE. 2/4 – Lules – Potrero de las Tablas

PE. 3/5 – Potrero de las Tablas – El Siambón

PE. 6/SH – Super Especial La Hoya

PE N°	PASADA 1	PASADA 2
<b>1</b>		
<b>2/4</b>		
<b>3/5</b>		
<b>7/10</b>		
<b>8/11</b>		
<b>9/12</b>		
<b>6/SH</b>		

## **ANEXO 3. NÚMEROS DE COMPETICIÓN Y PUBLICIDAD**

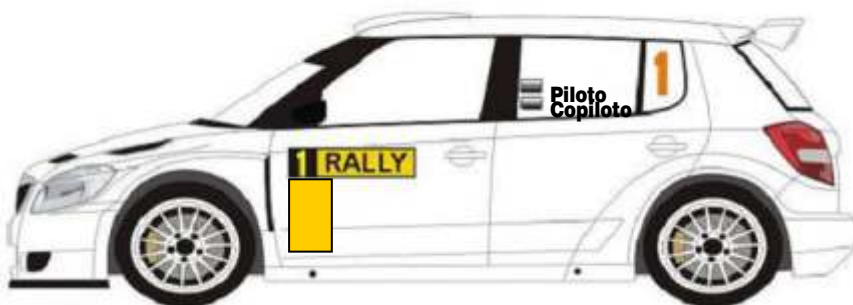

***LA PUBLICIDAD SERÁ DETALLADA EN UN  
BOLETIN***

**ANEXO 4. MAPAS DE SEGURIDAD Y CENTRO DE ATENCIONES**







### CENTROS MEDICOS CONTRATADOS

Hospital Tafi del Valle  
 Calle: Av. San Martín s/n  
 Ciudad: Tafi del Valle, (Tucumán)  
 Dirección: Av. San Martín s/n  
 Teléfono: 03867-421031  
 Fax: 03867-421033  
 Dr. Batuman  
 Sra. Olga Guanco

Sanatorio Modelo  
 Calle: 25 de Mayo 559  
 Ciudad: San Miguel de Tucumán,  
 (Tucumán)  
 Dirección: 25 de Mayo 559  
 Teléfono: (0381) 430-1305/2452  
 Fax: 0381-4308408/  
 Dr. Apas Julian  
 Ing. Hernán Zanelato













Hospital Padilla  
 Calle: Alberdi 550  
 Ciudad: San Miguel de Tucumán,  
 (Tucumán)  
 Dirección: Alberdi 550  
 Teléfono: 0381-4249002/4249576  
 Dirección/Fax: 0381-4248324  
 Dra. Fernandez Olga





















Hospital Regional de Concepción  
 Calle: San Luis 150  
 Ciudad: Concepción (Tucumán)  
 Dirección: San Luis 150  
 Teléfono: 03865-421784









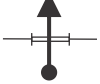

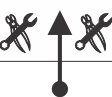
### CENTROS MEDICOS BASES

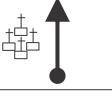





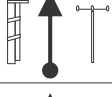

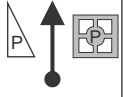

**SANATORIO GUEMES**  
 Calle: Acuña de Figueroa 1240  
 -Av. Córdoba 3933 (Guardia)  
 Ciudad: Capital Federal, (Buenos Aires)  
 Dirección: Acuña de Figueroa 1240  
 -Av. Córdoba 3933 (Guardia)  
 Teléfono: 4959-8200  
 Guardia: 4959-8200 int. 8488/8520 Fax  
 8157 admision int: 8445  
 Dr. Morgulis Néstor

**HOSPITAL BRITÁNICO de Bs. Aires**  
 Calle: Perdriel 74  
 Ciudad: Capital Federal, (Buenos Aires)  
 Dirección: Perdriel 74  
 Teléfono: 4304-1081 / 2051 4309-  
 6817/ 6813  
 Guardia: 4309-6451// Mail:  
 ariasgra@hbritanico.com.ar; Admision:  
 4309-6700  
 Director: Dr. Alejandro PoliGuardia:  
 Perdriel 74





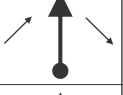

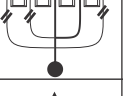
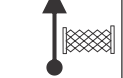

Simbolo	Significado
	Control Horario
	Largada Prueba Especial
	Final Prueba Especial
	Stop
	Radio
	Ambulancia
	Bomberos
	Precaución
	Peligro
	Muy peligroso
	Atención Angosto
	Señal de Celular
	Sin Señal de Celular

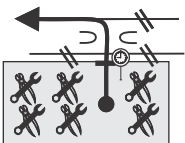
Simbolo	Significado						
	Lomada sobre asfalto						
	Lomo o lomada sobre tierra						
	Vado o Baden Seco						
	Vado o Baden con Cruce de Agua						
	Corte con Cruce de Agua						
	Corte Seco						
	Cartel rutero indicador						
	<table border="1"> <tr> <td>EL TRAPICHE</td> <td>2↑</td> </tr> <tr> <td>LA FLORIDA</td> <td>7→</td> </tr> <tr> <td>CAROLINA</td> <td>42↑</td> </tr> </table> 	EL TRAPICHE	2↑	LA FLORIDA	7→	CAROLINA	42↑
EL TRAPICHE	2↑						
LA FLORIDA	7→						
CAROLINA	42↑						
	Dirección a seguir						
	Número de figura						
							
	No utilizar lo cruzado con diagonales						
	Camino Asfaltado						
	Camino de tierra / ripio						
	Prueba Especial						
	Número de figura Distancia Regresiva						
	Puente						
	Alcantarilla						
	Guardaganado						
	Ingresar por tranquera						

Simbolo	Significado
	Vías ferrocarril
	Parques de Servicio
	Alambrado
	Arbol
	Cementerio
	Casa
	Escuela
	Iglesia o Capilla
	Hospital
	Piedra / Pirca
	Postes de electricidad
	Refugio
	Estación de Servicio

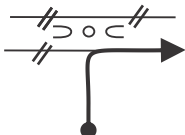
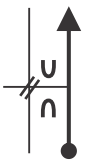
Simbolo	Significado
	Sendero
	Mojón indicador Kilometraje de ruta
	Semaforo
	Plaza / Plazoleta
	Hotel / Hostería
	Fabrica
	Tranquera en alambrado lateral
	Antena
	Gruta
	Camino en ascenso o Camino en descenso
	Camino sinuoso
	Estación de Peaje
	Alambrado olimpico







CH	Yerba Buena - Parque de Servicio	Distancia	Etapa	Pag.
CH	Predio La Hoya - Shakedown	<b>2.85</b>	Sector	III
		kms.		
Nro.	PRUEBA ESPECIAL	Kms.	Promedio	Tiempo Otorgado
	<b>ENLACE</b>		kms.	

Distancia		Dirección	Información	Distancia Regresiva
Total	Parcial			
0.00	0.00	 1	 <b>CH Sh</b> Salida Parque de Servicio Por calle Bascary Norte <div style="border: 1px solid black; padding: 2px; width: fit-content;">             GPS:              S 26 48 082              W 65 17 116              ALT. 500           </div>	<b>2.85</b>
0.06	0.06	 2	 Zona de Reabastecimiento de Combustible <div style="border: 1px solid black; padding: 2px; width: fit-content;">             GPS:              S 26 48 110              W 65 17 134              ALT. 503           </div>	<b>2.79</b>
0.12	0.06	 3	Por Av. Pte. Perón	<b>2.73</b>
0.98	0.86	 4	Cruza calle Mariano Moreno	<b>1.87</b>
2.76	1.78	 5	Deja Av. Pte. Perón	<b>0.09</b>
2.85	0.09	 6	 <b>CH Sh</b> Ingresa a Predio.	<b>0.00</b>

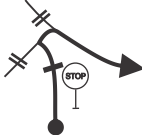

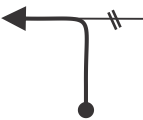
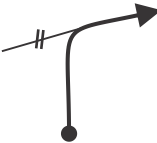
LPE	Shakedown	Distancia	Etapa	Pag.
CH	Yerba Buena - Parque de Servicio	kms.	Sector	IV
Nro.	PRUEBA ESPECIAL	Kms.	Promedio	Tiempo Otorgado
	SHAKEDOWN			

El Mapa del recorrido se entregará en un Anexo, que vendrá acompañado del Libro de Ruta.





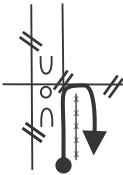





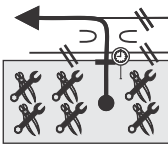

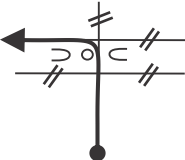

LPE	Shakedown	Distancia	Etapa	Pag.
CH	Yerba Buena - Parque de Servicio	kms.	Sector	V
Nro.	PRUEBA ESPECIAL	Kms.	Promedio	Tiempo Otorgado
	<b>SHAKEDOWN</b>			

Distancia		Dirección	Información	Distancia Regresiva
Total	Parcial			
0.00	0.00	 <p><b>1</b></p>	 Continúa por calle de tierra	4.48
0.12	0.12	 <p><b>2</b></p>		4.36
0.27	0.15	 <p><b>3</b></p>	Por Av. Pte. Perón	4.21
0.40	0.13	 <p><b>4</b></p>	Vuelve por Av. Pte. Perón	4.08
3.70	3.30	 <p><b>5</b></p>		0.78
4.04	0.34	 <p><b>6</b></p>	Vuelve por Av. Pte. Perón	0.44

LPE	Shakedown		Distancia	Etapa	Pag.
CH	Yerba Buena - Parque de Servicio		kms.	Sector	VI
Nro.	PRUEBA ESPECIAL	Kms.		Promedio	
	<b>SHAKEDOWN</b>				











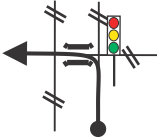

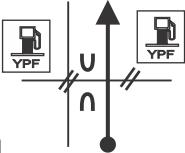
Distancia		Dirección	Información	Distancia Regresiva
Total	Parcial			
4.37	0.33		Por calle Bascary Norte e ingresa a Predio	0.11
4.48	0.11		 CH Ingreso - Parque de Service En poste de alambrado con M <div style="border: 1px solid black; padding: 2px; width: fit-content;">             GPS:              S 26 48 159              W 65 17 081              ALT. 500           </div>	0.00

CH	Yerba Buena - Parque de Servicio	Distancia	Etapa	Pag.
CH	Parque de Largada	10.32	Sector	VII
		kms.		
Nro.	PRUEBA ESPECIAL	Kms.	Promedio	Tiempo Otorgado
	<b>ENLACE</b>		kms.	

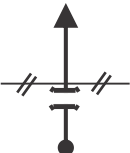

Distancia		Dirección	Información	Distancia Regresiva
Total	Parcial			
0.00	0.00	 <p><b>1</b></p>	 <b>CH</b> Salida Parque de Servicio Por calle Bascary Norte <div style="border: 1px solid black; padding: 2px; width: fit-content;">             GPS:              S 26 48 082              W 65 17 116              ALT. 500           </div>	10.32
0.06	0.06	 <p><b>2</b></p>	 Zona de Reabastecimiento de Combustible <div style="border: 1px solid black; padding: 2px; width: fit-content;">             GPS:              S 26 48 110              W 65 17 134              ALT. 503           </div>	10.26
0.12	0.06	 <p><b>3</b></p>	Por Av. Pte. Perón  Zona Urbana	10.20
1.63	1.51	 <p><b>4</b></p>	 Zona Urbana	8.69
2.60	0.97	 <p><b>5</b></p>	Por Avenida Camino del Peru  Zona Urbana	7.72
3.80	1.20	 <p><b>6</b></p>	<div style="border: 1px solid black; padding: 5px;">  Famaila (RN 301)   San Javier   S.M. de Tucumán         </div>	6.52

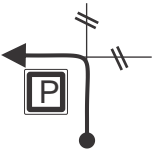





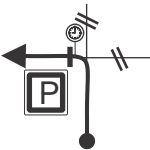





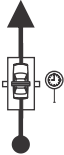

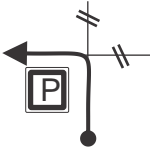
CH	Yerba Buena - Parque de Servicio	Distancia	Etapa	Pag.
CH	Parque de Largada	10.32	Sector	VIII
		kms.		
Nro.	PRUEBA ESPECIAL	Kms.	Promedio	Tiempo Otorgado
	<b>ENLACE</b>		kms.	

		Dirección	Información	Distancia Regresiva
Total	Parcial			
3.92	0.12	 <p>7</p>	Semáforo Por Av. Mate de Luna 	6.40
7.26	3.34	 <p>8</p>		3.06
8.30	1.04	 <p>9</p>	Monumento al BICENTENARIO 	2.02
8.87	0.57	 <p>10</p>	Continua por calle 24 de Septiembre 	1.45
10.08	1.21	 <p>11</p>		0.24
10.22	0.14	 <p>12</p>	Por calle LAPRIDA 	0.10

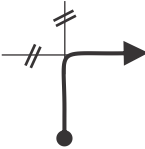

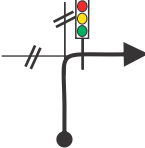







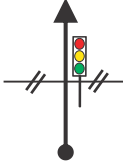

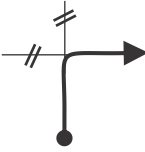
CH	Yerba Buena - Parque de Servicio	Distancia	Etapa	Pag.
CH	Parque de Largada	10.32	Sector	IX
		kms.		
Nro.	PRUEBA ESPECIAL	Kms.	Promedio	Tiempo Otorgado
	<b>ENLACE</b>			
			kms.	

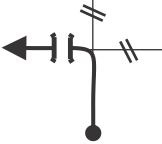
Distancia		Dirección	Información	Distancia Regresiva
Total	Parcial			
10.32	0.10		 <b>CH</b> Ingreso - Parque de Largada Por calle 25 DE MAYO PLAZA INDEPENDENCIA	0.00
		<b>13</b>		

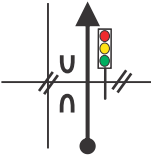



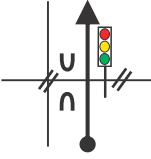





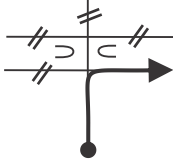

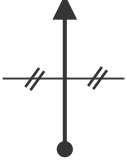
CH	Rampa de Largada Simbólica	Distancia	Etapa	Pag.
CH	Yerba Buena - Parque de Servicio	11.28	Sector	X
		kms.		
Nro.	PRUEBA ESPECIAL	Kms.	Promedio	Tiempo Otorgado
	<b>ENLACE</b>		kms.	

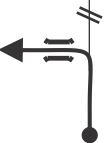
Distancia		Dirección	Información	Distancia Regresiva
Total	Parcial			
0.00	0.00	 1	 <b>LSP</b> Largada Simbólica Promocional PLAZA INDEPENDENCIA GPS: S 26 49 806 W 65 12 265 ALT. 445	11.28
0.08	0.08	 2	Por calle 24 DE SEPTIEMBRE  Zona Urbana	11.20
0.18	0.10	 3	Cruza calle LAPRIDA  Zona Urbana	11.10
0.35	0.17	 4	Por calle LAS HERAS  Zona Urbana	10.93
0.65	0.30	 5	<b>Semáforo</b> Por calle SAN LORENZO  Zona Urbana	10.63
1.30	0.65	 6	<b>Semáforo</b> Cruza calle Batalla de Chacabuco  Zona Urbana	9.98

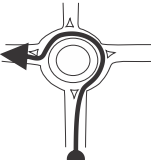
CH	Rampa de Largada Simbólica	Distancia	Etapa	Pag.
CH	Yerba Buena - Parque de Servicio	11.28	Sector	XI
		kms.		
Nro.	PRUEBA ESPECIAL	Kms.	Promedio	Tiempo Otorgado
	<b>ENLACE</b>		kms.	

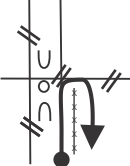
Distancia		Dirección	Información	Distancia Regresiva
Total	Parcial			
1.76	0.46	 <p>7</p>	Semáforo Cruza calle La Rioja 	9.52
2.10	0.34	 <p>8</p>	Por calle BERNABE ARAOZ 	9.18
2.38	0.28	 <p>9</p>	Por AV. 24 DE SEPTIEMBRE 	8.90
2.70	0.32	 <p>10</p>	Semáforo Por AV. MATE DE LUNA 	8.58
3.05	0.35	 <p>11</p>	Monumento al BICENTENARIO 	8.23
3.46	0.41	 <p>12</p>	Semáforo 	7.82

CH	Rampa de Largada Simbólica	Distancia	Etapa	Pag.
CH	Yerba Buena - Parque de Servicio	11.28	Sector	XII
		kms.		
Nro.	PRUEBA ESPECIAL	Kms.	Promedio	Tiempo Otorgado
	<b>ENLACE</b>		kms.	

Distancia		Dirección	Información	Distancia Regresiva
Total	Parcial			
7.40	3.94	 13	Por AV. CAMINO DE PERU  Zona Urbana	3.88
7.95	0.55	 14	 Zona Urbana	3.33
8.65	0.70	 15	CRUZA CANAL  Zona Urbana	2.63
8.70	0.05	 16	Por AV. PTE. PERON  Zona Urbana	2.58
11.17	2.47	 17	Por calle Bascary Norte e ingresa a Predio  Zona Urbana	0.11
11.28	0.11	 18	 <b>CH</b> Ingreso - Parque de Service En poste de alambrado con M <div style="border: 1px solid black; padding: 2px; width: fit-content;">             GPS:              S 26 48 159              W 65 17 081              ALT. 500           </div>	0.00











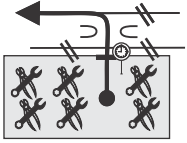

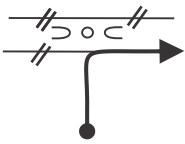

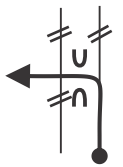
Día 1- Sección 1

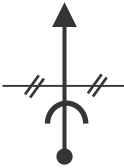

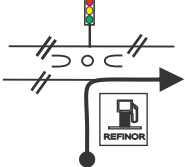

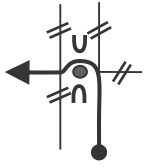



Etaapa 1

17 de Septiembre del 2016

CH	Parque de Servicio - Salida	Distancia	Etapa	Pag.
CH	0 Plaza de Monteros	51.84	Sector	1
Nro. PRUEBA ESPECIAL		Kms.	Promedio	Tiempo Otorgado
<b>ENLACE</b>			kms.	



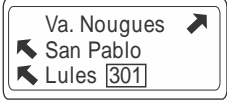
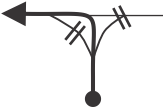

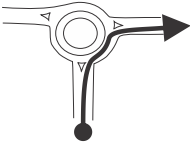

Distancia		Dirección	Información	Distancia Regresiva
Total	Parcial			
0.00	0.00	 <p><b>1</b></p>	 <b>CH</b> Salida Parque de Servicio Por calle Bascary Norte GPS: S 26 48 082 W 65 17 116 ALT: 500	51.84
0.12	0.12	 <p><b>2</b></p>	Por Av. Pte. Perón  Zona Urbana	51.72
0.98	0.86	 <p><b>3</b></p>	Por calle Mariano Moreno  Zona Urbana	50.86
1.31	0.33	 <p><b>4</b></p>	 Zona Urbana	50.53
2.25	0.94	 <p><b>5</b></p>	<b>Semáforo</b> Por Av. ACONQUIJA  En esta Estación de Servicio será la Técnica Previa y Final  Zona Urbana	49.59
2.67	0.42	 <p><b>6</b></p>	ROTONDA CON MASTIL Por AV. SOLANO VERA  Zona Urbana	49.17

CH	Parque de Servicio - Salida	Distancia	Etapa	Pag.
CH	0 Plaza de Monteros	51.84	Sector	2
		kms.		
Nro.	PRUEBA ESPECIAL	Kms.	Promedio	Tiempo Otorgado
	<b>ENLACE</b>		kms.	





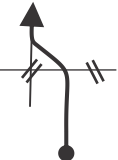



Distancia		Dirección	Información	Distancia Regresiva
Total	Parcial			
4.05	1.38	 <p>7</p>	Por RP N° 339 	47.79
5.12	1.07	 <p>8</p>		46.72
5.30	0.18	 <p>9</p>	LA RINCONADA 	46.54
8.45	3.15	 <p>10</p>		43.39
8.90	0.45	 <p>11</p>	POR RP N° 338 	42.94
10.45	1.55	 <p>12</p>		41.39

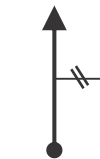







CH	Parque de Servicio - Salida	Distancia	Etapa	Pag.
CH	0 Plaza de Monteros	51.84	Sector	3
		kms.		
Nro.	PRUEBA ESPECIAL	Kms.	Promedio	Tiempo Otorgado
<b>ENLACE</b>			kms.	

Distancia		Dirección	Información	Distancia Regresiva
Total	Parcial			
11.00	0.55	 13		40.84
14.90	3.90	 14	<div style="border: 1px solid black; padding: 5px; width: fit-content;">           Quebrada de Lules            ↑ 2 km         </div>	36.94
17.35	2.45	 15	<div style="border: 1px solid black; padding: 5px; width: fit-content;">           RIO LULES         </div>	34.49
18.70	1.35	 16	Hace Rotonda y continúa por COLECTORA	33.14
19.00	0.30	 17	<div style="border: 1px solid black; padding: 5px; width: fit-content;">           Zona de Reabastecimiento de Combustible         </div> <div style="border: 1px solid black; padding: 5px; width: fit-content; margin-top: 10px;">           GPS:            S 26 55 699            W 65 20 070            ALT. 416         </div>	32.84
19.53	0.53	 18	VUELVE A RP N° 301 	32.31











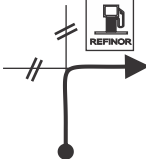

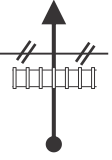
CH	Parque de Servicio - Salida	Distancia	Etapa	Pag.
CH	0 Plaza de Monteros	51.84	Sector	4
		kms.		
Nro.	PRUEBA ESPECIAL	Kms.	Promedio	Tiempo Otorgado
	<b>ENLACE</b>		kms.	

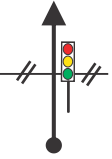
Distancia		Dirección	Información	Distancia Regresiva
Total	Parcial			
21.25	1.72	 19	 A la derecha Ingreso a LPE 2 y 4	30.59
28.95	7.70	 20		22.89
31.60	2.65	 21		20.24
34.20	2.60	 22	Acceso a Famaiilla	17.64
34.90	0.70	 23		16.94
35.25	0.35	 24		16.59

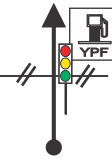

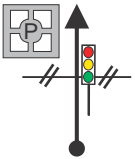

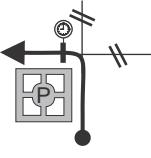





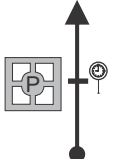

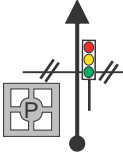
CH	Parque de Servicio - Salida	Distancia	Etapa	Pag.
CH	0 Plaza de Monteros	51.84	Sector	5
		kms.		
Nro.	PRUEBA ESPECIAL	Kms.	Promedio	Tiempo Otorgado
	<b>ENLACE</b>		kms.	

Distancia		Dirección	Información	Distancia Regresiva
Total	Parcial			
35.45	0.20	 25	Hace Rotonda y continúa por RN N° 38	16.39
35.80	0.35	 26	Semáforo	16.04
45.07	9.27	 27	Semáforo	6.77
45.30	0.23	 28	Continúa por RN N° 38	6.54
48.43	3.13	 29	<div style="border: 1px solid black; padding: 5px; display: inline-block;">             Monteros               Acceso Norte           </div>	3.41
49.55	1.12	 30	RIO ROMANO	2.29

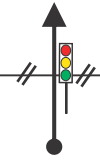

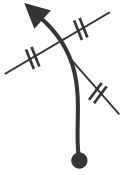

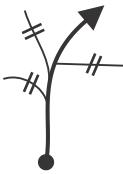

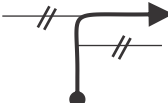

CH	Parque de Servicio - Salida	Distancia	Etapa	Pag.
CH	0 Plaza de Monteros	51.84	Sector	6
		kms.		
Nro.	PRUEBA ESPECIAL	Kms.	Promedio	Tiempo Otorgado
<b>ENLACE</b>				
			kms.	

Distancia		Dirección	Información	Distancia Regresiva
Total	Parcial			
50.85	1.30	 31	-DEJA RN N°38  -INGRESA A MONTEROS -Continúa por calle 24 DE SEPTIEMBRE	0.99
51.26	0.41	 32	 Zona Urbana	0.58
51.42	0.16	 33	Semáforo  Zona Urbana	0.42
51.56	0.14	 34	Semáforo  Zona Urbana	0.28
51.72	0.16	 35	Semáforo  Zona Urbana	0.12
51.84	0.12	 36	 CH 0 Ingreso a CH 0 Por calle Lamadrid  Zona Urbana	0.00

CH 0	Plaza de Monteros	Distancia <b>5.94</b> kms.	Etapa 1	Pag.
CH 1	Monteros		Sector 1	<b>7</b>
Nro.	PRUEBA ESPECIAL	Kms.	Promedio <b>35.64</b> kms.	Tiempo Otorgado <b>10'</b>
<b>ENLACE</b>				

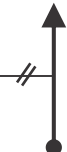
Distancia		Dirección	Información	Distancia Regresiva
Total	Parcial			
0.00	0.00	 <p><b>1</b></p>	 <b>CH 0</b> Salida CH 0 Por calle Lamadrid <div style="border: 1px solid black; padding: 2px; font-size: small;">             GPS:              S 27 09 901              W 65 29 872              ALT. 353           </div>	<b>5.94</b>
0.05	0.05	 <p><b>2</b></p>	<b>Semáforo</b> Continúa por calle SAN MARTIN  Zona Urbana	<b>5.89</b>
0.35	0.30	 <p><b>3</b></p>	<b>Semáforo</b>  Zona Urbana	<b>5.59</b>
0.77	0.42	 <p><b>4</b></p>	<b>Semáforo</b>  Zona Urbana	<b>5.17</b>
0.92	0.15	 <p><b>5</b></p>	 Zona Urbana	<b>5.02</b>
1.17	0.25	 <p><b>6</b></p>	Por calle COLON  Zona Urbana	<b>4.77</b>

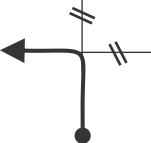







CH	0	Plaza de Monteros	Distancia	Etapa 1	Pag.
CH	1	Monteros	5.94		8
			kms.	Sector 1	
Nro.	PRUEBA ESPECIAL		Kms.	Promedio	Tiempo Otorgado
	<b>ENLACE</b>			35.64	10'
				kms.	

Distancia		Dirección	Información	Distancia Regresiva
Total	Parcial			
2.00	0.83	 7	POR RP N° 325 	3.94
2.40	0.40	 8		3.54
4.03	1.63	 9		1.91
4.49	0.46	 10	 A la izquierda Ingreso a FPE 1	1.45
5.84	1.35	 11	DEJA RP N° 325	0.10
5.94	0.10	 12	 <b>CH 1</b> En Árbol con letra M  <div style="border: 1px solid black; padding: 2px; display: inline-block;">1er. Auto 09:40 hs.</div>	0.00

LPE	1	Monteros	Distancia	Etapa 1	Pag.
CH	2	Lules	49.90	Sector 2	9
			kms.		
Nro.	PRUEBA ESPECIAL		Kms.	Promedio	Tiempo Otorgado
1	Monteros Monteros		4.44	49.90 kms.	1:00'

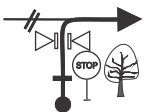

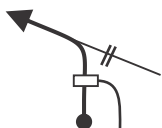



Distancia		Dirección	Información	Distancia Regresiva
Total	Parcial			
0.00	0.00		LPE 1 En Arbol con Letra B. GPS: S 27 10 782 W 65 32 780 ALT. 369 1er. Auto 09:43 hs	49.90
0.68	0.68		VEEDOR	49.22
1.86	1.18			48.04
2.33	0.47			47.57
2.63	0.30			47.27
3.30	0.67		CHICANA Por detrás de Árbol 	46.60

LPE	1	Monteros	Distancia	Etapa 1	Pag.
CH	2	Lules	49.90	Sector 2	10
			kms.		
Nro.	PRUEBA ESPECIAL		Kms.	Promedio	Tiempo Otorgado
1	Monteros Monteros		4.44	49.90	1:00'
			kms.		



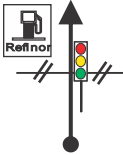



Distancia		Dirección	Información	Distancia Regresiva
Total	Parcial			
3.78	0.48	 7 <span style="float: right;">0.66</span>		46.12
4.13	0.35	 8 <span style="float: right;">0.31</span>		45.77
4.44	0.31	 9 <span style="float: right;">0.00</span>	 FPE 1 En Árbol con letra B. <div style="border: 1px solid black; padding: 2px; width: fit-content; margin-top: 5px;">             GPS:              S 27 10 805              W 65 32 021              ALT. 367           </div>	45.46
4.74	0.30	 10 <span style="float: right;">0.00</span>	 En Árbol con letra M Continúa por Rp N° 325	45.16
6.67	1.93	 11 <span style="float: right;">0.00</span>		43.23
7.98	1.31	 12 <span style="float: right;">0.00</span>	<div style="border: 1px solid black; padding: 5px; width: fit-content;">  Monteros 38   Simoca 157            Concepción →         </div> Por Rn N° 38	41.92











LPE	1	Monteros	Distancia	Etapa 1	Pag.
CH	2	Lules	49.90	Sector 2	11
Nro. PRUEBA ESPECIAL			kms.		
1	Monteros Monteros		Kms.	Promedio	Tiempo Otorgado
			4.44	49.90	1:00'
			kms.		

Distancia		Dirección	Información	Distancia Regresiva
Total	Parcial			
8.80	0.82	 13		41.10
9.25	0.45	 14	Semáforo	40.65
9.53	0.28	 15	Semáforo	40.37
10.90	1.37	 16		39.00
14.92	4.02	 17		34.98
15.12	0.20	 18	Continúa por RN N° 38	34.78



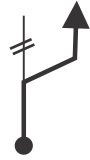





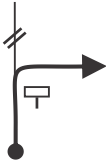

LPE	1	Monteros	Distancia	Etapa 1	Pag.
CH	2	Lules	49.90	Sector 2	12
Nro. PRUEBA ESPECIAL			kms.		
1	Monteros Monteros		Kms.	Promedio	Tiempo Otorgado
			4.44	49.90	1:00'
			kms.		

Distancia		Dirección	Información	Distancia Regresiva
Total	Parcial			
24.68	9.56	 19	Semáforo	25.22
25.10	0.42	 20	Por Rp N°301	24.80
25.85	0.75	 21		24.05
26.71	0.86	 22		23.19
29.07	2.36	 23		20.83
31.68	2.61	 24		18.22













LPE	1	Monteros	Distancia	Etapa 1	Pag.
CH	2	Lules	49.90	Sector 2	13
			kms.		
Nro.	PRUEBA ESPECIAL		Kms.	Promedio	Tiempo Otorgado
1	Monteros Monteros		4.44	49.90	1:00'
			kms.		

Distancia		Dirección	Información	Distancia Regresiva
Total	Parcial			
39.53	7.85	 25	 A la izquierda Ingreso a LPE 2 y 4	10.37
41.03	1.50	 26		8.87
41.90	0.87	 27	SE VUELVE POR RP N° 301	8.00
42.20	0.30	 28	Por Colectora	7.70
42.25	0.05	 29	 Zona de Reabastecimiento de Combustible  <div style="border: 1px solid black; padding: 2px;">           GPS:            S 26 55 699            W 65 20 070            ALT. 416         </div>	7.65
42.82	0.57	 30	VUELVE A RP N° 301  	7.08

LPE	1	Monteros	Distancia	Etapa 1	Pag.
CH	2	Lules	49.90	Sector 2	14
Nro. PRUEBA ESPECIAL			kms.		
1	Monteros Monteros		Promedio	Tiempo Otorgado	
			4.44	49.90	1:00'
			kms.		

Distancia		Dirección	Información	Distancia Regresiva
Total	Parcial			
44.50	1.68	 31	DEJA RP N° 301 CONTINUA POR RP N° 341 	5.40
44.91	0.41	 32		4.99
46.21	1.30	 33		3.69
47.40	1.19	 34	PAPELERA	2.50
47.52	0.12	 35	COMIENZA TIERRA	2.38
49.90	2.38	 36	 <b>CH 2</b> En Árbol con letra M 	0.00





LPE	2	Lules	Distancia	Etapa 1	Pag.
CH	3	Potrero de las Tablas	31.06	Sector 3	15
			kms.		
Nro.	PRUEBA ESPECIAL		Kms.	Promedio	Tiempo Otorgado
2/4	Lules Potrero de las Tablas		22.50	46.59	40'
				kms.	

Distancia		Dirección	Información	Distancia Regresiva
Total	Parcial			
0.00	0.00	 1 22.51	 LPE 2/4  En Árbol con Letra B. GPS: S 26 55 493 W 65 22 750 ALT. 487 1er. Auto 10:46 hs	31.06
0.25	0.25	 2 22.26		30.81
0.84	0.59	 3 21.67		30.22
14.66	13.82	 4 7.85	 Rescate Médico  Comunicación GPS: S 26 53 174 W 65 24 373 ALT. 1067	16.40
21.92	7.26	 5 0.59		9.14
22.01	0.09	 6 0.50		9.05



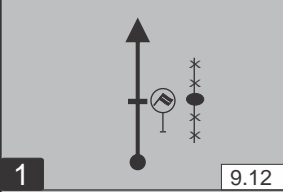

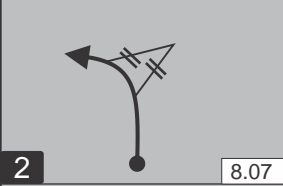
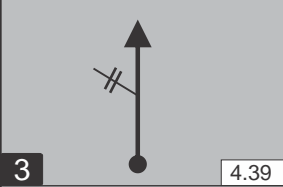
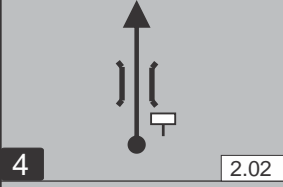
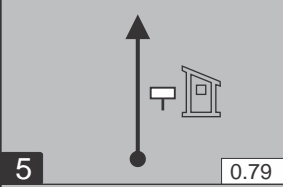
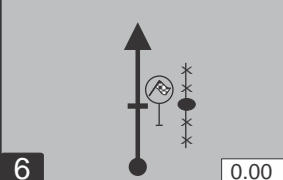

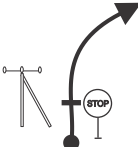

LPE	2	Lules	Distancia	Etapa 1	Pag.
CH	3	Potrero de las Tablas	31.06	Sector 3	16
			kms.		
Nro.	PRUEBA ESPECIAL		Kms.	Promedio	Tiempo Otorgado
2/4	Lules Potrero de las Tablas		22.50	46.59	40'
			kms.		

Distancia		Dirección	Información	Distancia Regresiva
Total	Parcial			
22.51	0.50		FPE 2/4 En Árbol con letra B. GPS: S 26 51 096 W 65 25 974 ALT. 689	8.55
23.02	0.51		 En Árbol con letra M.	8.04
28.15	5.13			2.91
30.16	2.01			0.90
30.47	0.31			0.59
31.06	0.59		CH 3 En Poste de Alambrado con letra M. 1er. Auto 11:28hs.	0.00

LPE	3	Potrero de las Tablas	Distancia	Etapa 1	Pag.
CH	3a	Flexi Service - Ingreso	68.02		17
			kms.	Sector 4	
Nro.	PRUEBA ESPECIAL		Kms.	Promedio	Tiempo Otorgado
3/5	Potrero de las Tablas El Siambón		9.12	45.34	1:30'
				kms.	







Distancia		Dirección	Información	Distancia Regresiva
Total	Parcial			
0.00	0.00		 LPE 3/5  En poste de alambrado con letra B. 1er. Auto 11:29 hs GPS: S 26 48 261 W 65 28 142 ALT. 962	68.02
1.05	1.05			66.97
4.73	3.68			63.29
7.10	2.37		RIO GRANDE	60.92
8.33	1.23		EL SIAMBON	59.69
9.12	0.79		 FPE 3/5  En poste de alambrado con letra B. GPS: S 26 45 523 W 65 27 647 ALT. 986	58.90

LPE	3	Potrero de las Tablas	Distancia	Etapa 1	Pag.
CH	3a	Flexi Service - Ingreso	68.02		18
			kms.	Sector 4	
Nro.	PRUEBA ESPECIAL		Kms.	Promedio	Tiempo Otorgado
3/5	Potrero de las Tablas El Siambón		9.12	45.34	1:30
				kms.	

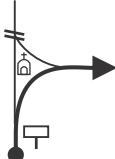
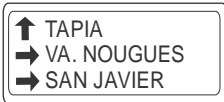
Distancia		Dirección	Información	Distancia Regresiva
Total	Parcial			
9.40	0.28	 7	 En Poste doble con letra M.	58.62
10.01	0.61	 8		58.01
12.19	2.18	 9	COMIENZA ASFALTO	55.83
14.11	1.92	 10		53.91
17.40	3.29	 11	 Zona de Reabastecimiento de Combustible  <div style="border: 1px solid black; padding: 2px; width: fit-content;">           GPS:            S 26 41 804            W 65 25 704            ALT. 1211         </div>	50.62
19.86	2.46	 12		48.16

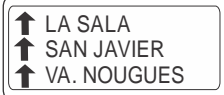



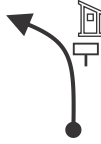
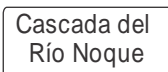



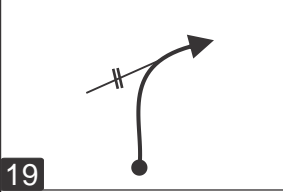
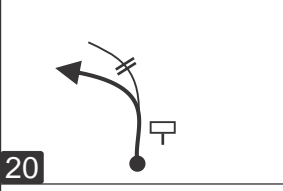
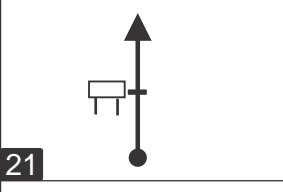
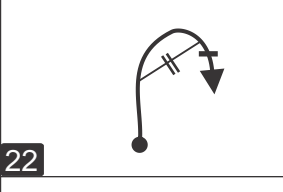
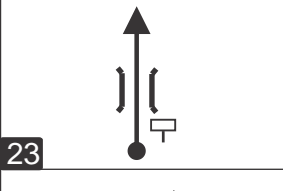
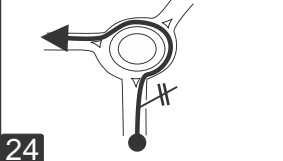



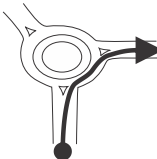

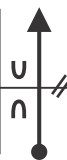
LPE	3	Potrero de las Tablas	Distancia	Etapa 1	Pag.
CH	3a	Flexi Service - Ingreso	68.02		19
			kms.	Sector 4	
Nro.	PRUEBA ESPECIAL		Kms.	Promedio	Tiempo Otorgado
3/5	Potrero de las Tablas El Siambón		9.12	45.34	1:30
				kms.	

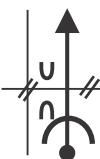
Distancia		Dirección	Información	Distancia Regresiva
Total	Parcial			
24.86	5.00	 13	Por RP N° 340 	43.16
25.07	0.21	 14		42.95
31.14	6.07	 15		36.88
32.97	1.83	 16	PISO DETERIORADO 	35.05
37.00	4.03	 17	DESVÍO OBRA EN CONSTRUCCIÓN 	31.02
40.92	3.92	 18		27.10

LPE	3	Potrero de las Tablas	Distancia	Etapa 1	Pag.
CH	3a	Flexi Service - Ingreso	68.02	Sector 4	20
			kms.		
Nro.	PRUEBA ESPECIAL		Kms.	Promedio	Tiempo Otorgado
3/5	Potrero de las Tablas El Siambón		9.12	45.34	1:30'
			kms.		

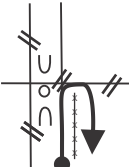
Distancia		Dirección	Información	Distancia Regresiva
Total	Parcial			
45.28	4.36			22.74
51.32	6.04		<div style="border: 1px solid black; padding: 5px;"> <p>↑ LOMA BOLA ↑ VA. NOUGUES ← S.M. de Tucumán</p> </div>	16.70
52.60	1.28		<p><i>i</i> LPE 9/12</p>	15.42
59.40	6.80		<p><i>i</i> FPE 9/12</p>	8.62
61.90	2.50		<div style="border: 1px solid black; padding: 5px;"> <p>RIO MUERTO</p> </div>	6.12
63.00	1.10			5.02









LPE	3	Potrero de las Tablas	Distancia	Etapa 1	Pag.
CH	3a	Flexi Service - Ingreso	68.02	Sector 4	21
			kms.		
Nro.	PRUEBA ESPECIAL		Kms.	Promedio	Tiempo Otorgado
3/5	Potrero de las Tablas El Siambón		9.12	45.34	1:30
				kms.	

Distancia		Dirección	Información	Distancia Regresiva
Total	Parcial			
63.95	0.95	 25	POR AV. PTE PERON  Zona Urbana	4.07
64.59	0.64	 26	 Zona Urbana	3.43
67.30	2.71	 27	Cruza calle Bascary Norte  Zona Urbana	0.72
67.60	0.30	 28	Se vuelve por Av. Pte. Perón  Zona Urbana	0.42
67.91	0.31	 29	Por calle Bascary Norte e ingresa a Predio  Zona Urbana	0.11
68.02	0.11	 30	 <b>CH 3A</b> Ingreso - Flexie Service En poste de alambrado con M <div style="border: 1px solid black; padding: 2px; font-size: small;">             GPS:              S 26 48 159              W 65 17 081              ALT. 500           </div>	0.00





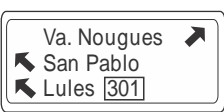
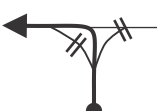



CH	3d	Reagrupamiento - Salida	Distancia	Etapa 1	Pag.
CH	4	Lules	26.65	Sector 8	22
			kms.		
Nro.	PRUEBA ESPECIAL		Kms.	Promedio	Tiempo Otorgado
	<b>ENLACE</b>			45.68	35'
				kms.	

Distancia		Dirección	Información	Distancia Regresiva
Total	Parcial			
0.00	0.00	 1	 CH 3D Salida Parque de Servicio Por calle Bascary Norte <div style="border: 1px solid black; padding: 2px; font-size: small;">           GPS:            S 26 48 082            W 65 17 116            ALT. 500         </div>	26.65
0.12	0.12	 2	Por Av. Pte. Perón  Zona Urbana	26.53
0.98	0.86	 3	Por calle Mariano Moreno  Zona Urbana	25.67
1.31	0.33	 4	 Zona Urbana	25.34
2.25	0.94	 5	Semáforo Por Av. ACONQUIJA  Zona Urbana	24.40
2.67	0.42	 6	ROTONDA CON MASTIL Por AV. SOLANO VERA  Zona Urbana	23.98





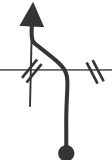



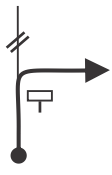

CH	3d	Reagrupamiento - Salida	Distancia	Etapa 1	Pag.
CH	4	Lules	26.65	Sector 8	23
			kms.		
Nro.	PRUEBA ESPECIAL		Kms.	Promedio	Tiempo Otorgado
	<b>ENLACE</b>			45.68	35'
				kms.	

Distancia		Dirección	Información	Distancia Regresiva
Total	Parcial			
4.05	1.38	 <p>7</p>	Por RP N° 339  Zona Urbana	22.60
5.12	1.07	 <p>8</p>	 Zona Urbana	21.53
5.30	0.18	 <p>9</p>	LA RINCONADA  Zona Urbana	21.35
8.45	3.15	 <p>10</p>		18.20
8.90	0.45	 <p>11</p>	POR RP N° 338 	17.75
10.45	1.55	 <p>12</p>		16.20

CH	3d	Reagrupamiento - Salida	Distancia	Etapa 1	Pag.
CH	4	Lules	26.65	Sector 8	24
			kms.		
Nro.	PRUEBA ESPECIAL		Kms.	Promedio	Tiempo Otorgado
<b>ENLACE</b>			45.68	35'	
			kms.		

Distancia		Dirección	Información	Distancia Regresiva
Total	Parcial			
11.00	0.55	 13		15.65
14.90	3.90	 14	<div style="border: 1px solid black; padding: 5px; width: fit-content;">           Quebrada de Lules            ↑ 2 km         </div>	11.75
17.35	2.45	 15	<div style="border: 1px solid black; padding: 5px; width: fit-content;">           RIO LULES         </div>	9.30
18.70	1.35	 16	Hace Rotonda y continúa por COLECTORA	7.95
19.00	0.30	 17	<div style="border: 1px solid black; padding: 5px; width: fit-content;">  Zona de Reabastecimiento de Combustible         </div> <div style="border: 1px solid black; padding: 5px; width: fit-content; margin-top: 10px;">           GPS:            S 26 55 699            W 65 20 070            ALT. 416         </div>	7.65
19.53	0.53	 18	VUELVE A RP N° 301 	7.12

CH	3d	Reagrupamiento - Salida	Distancia	Etapa 1	Pag.
CH	4	Lules	26.65	Sector 8	25
			kms.		
Nro.	PRUEBA ESPECIAL		Kms.	Promedio	Tiempo Otorgado
	<b>ENLACE</b>			45.68	35'
				kms.	

Distancia		Dirección	Información	Distancia Regresiva
Total	Parcial			
21.25	1.72	 19	DEJA RP N° 301 CONTINUA POR RP N° 341 	5.40
21.66	0.41	 20		4.99
22.96	1.30	 21		3.69
24.15	1.19	 22	PAPELERA	2.50
24.27	0.12	 23	COMIENZA TIERRA	2.38
26.65	2.38	 24	 <b>CH 4</b> En Árbol con letra M 	0.00

LPE	4	Lules		Distancia	Etapa 1	Pag.
CH	5	Potrero de las Tablas		31.06		26
				kms.	Sector 9	
Nro.	PRUEBA ESPECIAL		Kms.	Promedio	Tiempo Otorgado	
2/4	Lules Potrero de las Tablas		22.50	46.59	40'	
				kms.		







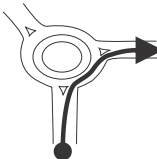

Se repite ídem a páginas 15 y 16.

LPE	5	Potrero de las Tablas		Distancia	Etapa 1	Pag.
CH	6	La Hoya		64.80		26
				kms.	Sector 10	
Nro.	PRUEBA ESPECIAL		Kms.	Promedio	Tiempo Otorgado	
3/5	Potrero de las Tablas El Siambón		9.12	45.74	1:25'	
				kms.		

Se repite ídem a páginas 17, 18, 19 y 20 (hasta figura 24 ).









LPE	5	Potrero de las Tablas	Distancia	Etapa 1	Pag.
CH	6	La Hoya	64.80	27	
			kms.	Sector 10	
Nro.	PRUEBA ESPECIAL		Kms.	Promedio	Tiempo Otorgado
3/5	Potrero de las Tablas El Siambón		9.12	45.74	1:25'
			kms.		

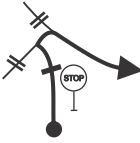

Distancia		Dirección	Información	Distancia Regresiva
Total	Parcial			
63.95	0.95	 25	POR AV. PTE PERON  Zona Urbana	4.27
64.59	0.51	 26	Se vuelve por Av. Pte. Perón Frente a Negocio de Comida Sana  Zona Urbana	3.76
64.71	2.14	 27	Deja Av. Pte. Perón  Zona Urbana	1.62
64.80	1.62	 28	 CH 6 Ingresa a Predio.  Zona Urbana <b>1er. Auto</b> <b>16:50hs.</b>	0.00

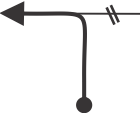
LPE	6	La Hoya	Distancia	Etapa 1	Pag.
CH	6a	Zona Técnica - Ingreso	6.28	Sector 11	28
			kms.		
Nro.	PRUEBA ESPECIAL		Kms.	Promedio	Tiempo Otorgado
6	Super Especial LA HOYA		1.80	25.12	15'
				kms.	

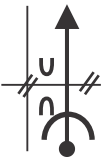
El Mapa del recorrido se entregará en un Anexo, que vendrá acompañado del Libro de Ruta.

LPE	6	La Hoya	Distancia	Etapa 1	Pag.
CH	6a	Zona Técnica - Ingreso	6.28		29
			kms.	Sector 11	
Nro.	PRUEBA ESPECIAL		Kms.	Promedio	Tiempo Otorgado
6	Super Especial LA HOYA		1.80	25.12	15'
				kms.	

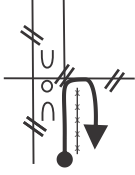
Distancia		Dirección	Información	Distancia Regresiva
Total	Parcial			
0.00	0.00	 <p>1</p>	 Continúa por calle de tierra	4.48
0.12	0.12	 <p>2</p>		4.36
0.27	0.15	 <p>3</p>	Por Av. Pte. Perón	4.21
0.40	0.13	 <p>4</p>	Vuelve por Av. Pte. Perón	4.08
3.70	3.30	 <p>5</p>		0.78
4.04	0.34	 <p>6</p>		0.44

LPE	6	La Hoya	Distancia		Etapa 1	Pag.
CH	6a	Zona Técnica - Ingreso	6.28		30	
			kms.		Sector 11	
Nro.	PRUEBA ESPECIAL		Kms.		Promedio	Tiempo Otorgado
6	Super Especial LA HOYA		1.80		25.12	15'
			kms.			
Distancia		Dirección	Información		Distancia Regresiva	
Total	Parcial					
4.37	0.33		Por calle Bascary Norte e ingresa a Predio y a ZONA TECNICA		0.11	
		7				
4.48	0.11		 CH 6A Ingreso - Parque de Service En poste de alambrado con M		0.00	
		8	GPS: S 26 48 159 W 65 17 081 ALT. 500			

**i** EL CH 6D SE ENCONTRARÁ A LA SALIDA DEL CH 6C



Día 2- Sección 3









Etapa 2

18 de Septiembre del 2016

CH 6d	Parque de Servicio - Salida	Distancia	Etapa 2	Pag.
CH 7	San Pablo	11.77	Sector 12	31
Nro.	PRUEBA ESPECIAL	Kms.	Promedio	Tiempo Otorgado
	<b>ENLACE</b>		35.31	20'
			kms.	

Distancia		Dirección	Información	Distancia Regresiva
Total	Parcial			
0.00	0.00	 1	CH 6F Salida Parque de Servicio Por calle Bascary Norte <div style="border: 1px solid black; padding: 2px; width: fit-content;">             GPS:              S 26 48 082              W 65 17 116              ALT. 500           </div>	11.77
0.12	0.12	 2	Por Av. Pte. Perón  Zona Urbana	11.65
0.98	0.86	 3	Por calle Mariano Moreno  Zona Urbana	10.79
1.31	0.33	 4	 Zona Urbana	10.46
2.25	0.94	 5	<b>Semáforo</b> Por Av. ACONQUIJA En esta Estación de Servicio será la Técnica Previa y Final  Zona Urbana	9.52
2.67	0.42	 6	ROTONDA CON MASTIL Por AV. SOLANO VERA  Zona Urbana	9.10

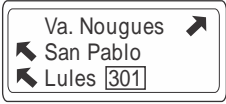
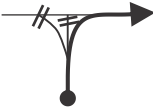
CH	6d	Parque de Servicio - Salida	Distancia	<i>Etapa 2</i>	<i>Pag.</i>
CH	7	San Pablo	11.77		
Nro.			PRUEBA ESPECIAL		Kms.
ENLACE			Promedio	Tiempo Otorgado	
			35.31	20'	
			kms.		













Distancia		Dirección	Información	Distancia Regresiva
Total	Parcial			
4.05	1.38	 7	Por RP N° 339  Zona Urbana	7.72
5.12	1.07	 8	 Zona Urbana	6.65
5.30	0.18	 9	LA RINCONADA  Zona Urbana	6.47
8.45	3.15	 10		3.32
8.90	0.45	 11	POR RP N° 338 	2.87
9.33	0.43	 12	VILLA NOUGUES	2.44

CH	6d	Parque de Servicio - Salida	Distancia	Etapa 2	Pag.
CH	7	San Pablo	11.77	Sector 12	33
Nro.	PRUEBA ESPECIAL		Kms.	Promedio	Tiempo Otorgado
	<b>ENLACE</b>			35.31 kms.	20'









Distancia		Dirección	Información	Distancia Regresiva
Total	Parcial			
11.77	2.44		 <b>CH 7</b> En ingreso a Salón LAS MARIAS. <div style="border: 1px solid black; padding: 2px; display: inline-block;">1er. Auto 09:15 hs.</div>	0.00
		<b>13</b>		





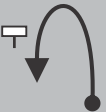



LPE	7	San Pablo	Distancia	Etapa 2	Pag.
CH	8	Villa Nougues	11.26	Sector 13	34
			kms.		
Nro.	PRUEBA ESPECIAL		Kms.	Promedio	Tiempo Otorgado
7/10	San Pablo Villa Nougues		10.22	45.04	15'
					kms.

Distancia		Dirección	Información	Distancia Regresiva
Total	Parcial			
0.00	0.00	 1 10.22	 <b>LPE 7/10</b>  En poste de madera con letra M. GPS: S 26 51 882 W 65 20 672 ALT. 578 1er. Auto 09:18 hs	11.26
1.85	1.85	 2 8.37	Zona de Obras 	9.41
2.50	0.65	 3 7.72		8.76
3.90	1.40	 4 6.32		7.36
4.85	0.95	 5 5.37		6.41
5.20	0.35	 6 5.02	VEEDOR	6.06

LPE	7	San Pablo	Distancia	Etapa 2	Pag.
CH	8	Villa Nougues	11.26	Sector 13	35
			kms.		
Nro.		PRUEBA ESPECIAL	Kms.	Promedio	Tiempo Otorgado
7/10	San Pablo Villa Nougues		10.22	45.04	15'
				kms.	

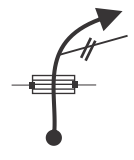
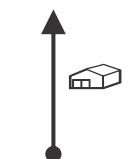
Distancia		Dirección	Información	Distancia Regresiva
Total	Parcial			
5.89	0.69	 <b>7</b> <span style="float: right;">4.33</span>	VEEDOR	5.37
6.18	0.29	 <b>8</b> <span style="float: right;">4.04</span>	VEEDOR	5.08
7.37	1.19	 <b>9</b> <span style="float: right;">2.85</span>		3.89
9.05	1.68	 <b>10</b> <span style="float: right;">1.17</span>	Zona Urbana	2.21
9.60	0.55	 <b>11</b> <span style="float: right;">0.62</span>		1.66
10.22	0.62	 <b>12</b> <span style="float: right;">0.00</span>	 FPE 7/10  En Arbol con Letra B. GPS: S 26 51 419 W 65 22 527 ALT. 1266	1.04

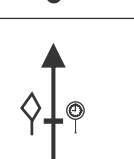
LPE	7	San Pablo	Distancia	Etapa 2	Pag.
CH	8	Villa Nougues	11.26	Sector 13	36
			kms.		
Nro.		PRUEBA ESPECIAL	Kms.	Promedio	Tiempo Otorgado
7/10	San Pablo Villa Nougues		10.22	45.04	15'
			kms.		

Distancia		Dirección	Información	Distancia Regresiva
Total	Parcial			
10.44	0.22	 13	 En poste de Cemento con letra B. Frente a Iglesia.	0.82
10.85	0.41	 14		0.41
11.10	0.25	 15	POLICIA	0.16
11.16	0.06	 16		0.10
11.26	0.10	 17	 CH 8 En cartel rombo con letra M.  1er. Auto 09:33 hs.	0.00

LPE	8	Villa Nougues	Distancia	Etapa 2	Pag.
CH	9	San Javier	13.33	Sector 14	37
			kms.		
Nro.	PRUEBA ESPECIAL		Kms.	Promedio	Tiempo Otorgado
8/11	Villa Nougues San Javier		10.78	31.99	25'
					kms.

Distancia		Dirección	Información	Distancia Regresiva
Total	Parcial			
0.00	0.00	 1 <span style="float: right;">10.78</span>	LPE 8/11 En cartel vial con letra B. <div style="border: 1px solid black; padding: 2px; display: inline-block;">             1er. Auto 09:36 hs           </div> <div style="border: 1px solid black; padding: 2px; display: inline-block; margin-left: 10px;">             GPS: S 26 51 350 W 65 22 914 ALT. 1336           </div>	13.33
1.45	1.45	 2 <span style="float: right;">9.33</span>	VEEDOR	11.88
1.65	0.20	 3 <span style="float: right;">9.13</span>		11.68
2.34	0.69	 4 <span style="float: right;">8.44</span>		10.99
3.38	1.04	 5 <span style="float: right;">7.40</span>	<div style="border: 1px solid black; padding: 5px;">  Loma Bola   San Javier   Cristo Bendicente         </div>	9.95
4.08	0.70	 6 <span style="float: right;">6.70</span>	Comienza a descender 	9.25









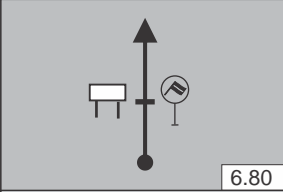

LPE	8	Villa Nougues	Distancia	Etapa 2	Pag.
CH	9	San Javier	13.33	Sector 14	38
			kms.		
Nro.	PRUEBA ESPECIAL		Kms.	Promedio	Tiempo Otorgado
8/11	Villa Nougues San Javier		10.78	31.99	25'
			kms.		

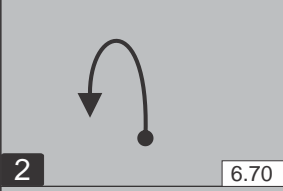
Distancia		Dirección	Información	Distancia Regresiva
Total	Parcial			
7.72	3.64		Las Piramides	5.61
8.68	0.96		Piso deteriorado 	4.65
9.03	0.35			4.30
10.20	1.17		VEEDOR	3.13
10.55	0.35		Zona de Protección de Cuerdas	2.78
10.64	0.09		VEEDOR	2.69

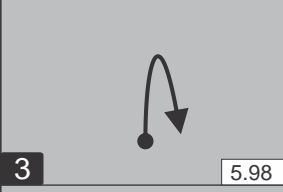

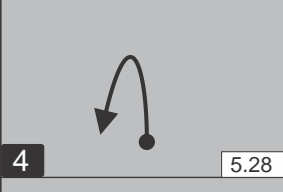

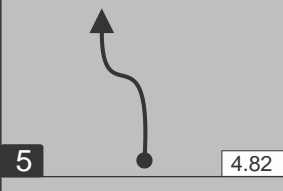
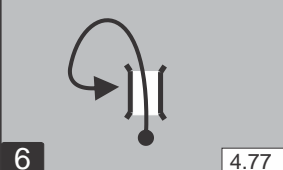





LPE	8	Villa Nougues	Distancia	Etapa 2	Pag.
CH	9	San Javier	13.33	Sector 14	39
			kms.		
Nro.	PRUEBA ESPECIAL		Kms.	Promedio	Tiempo Otorgado
8/11	Villa Nougues San Javier		10.78	31.99	25'
			kms.		

Distancia		Dirección	Información	Distancia Regresiva
Total	Parcial			
10.78	0.14	 13 0.00	FPE 8/11 En poste de Alambrado con letra B. <div style="border: 1px solid black; padding: 2px; margin-top: 5px;">             GPS:              S 26 48 662              W 65 21 796              ALT. 1260           </div>	2.55
11.17	0.39	 14	 En Zona de Descanso	2.16
11.97	0.80	 15	<div style="border: 1px solid black; padding: 5px; width: fit-content;">             S.M. de Tucumán     Raco                Tapia           </div>	1.36
12.05	0.08	 16	San Javier  Zona Urbana	1.28
13.33	1.28	 17	CH 9 En mojón con letra M. <div style="border: 1px solid black; padding: 2px; margin-top: 5px;">             1er. Auto              10:01 hs.           </div>	0.00

LPE	9	San Javier	Distancia	Etapa 2	Pag.
CH	9A	Flexi Service - Ingreso	15.42		40
			kms.	Sector 15	
Nro.	PRUEBA ESPECIAL		Kms.	Promedio	Tiempo Otorgado
9/12	San Javier Yerba Buena		6.80	46.26	20'
				kms.	



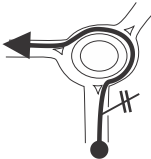







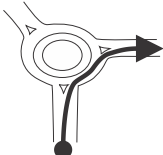

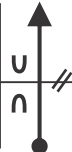
Distancia		Dirección	Información	Distancia Regresiva
Total	Parcial			
0.00	0.00		 <b>LPE 9/12</b> En cartel vial con letra B. <div style="border: 1px solid black; padding: 2px; display: inline-block;">1er. Auto 10:04 hs</div> <div style="border: 1px solid black; padding: 2px; display: inline-block; margin-left: 10px;">GPS: S 26 48 088 W 65 21 264 ALT. 1180</div> 	15.42
0.10	0.10			15.32
0.82	0.72			14.60
1.52	0.70			13.90
1.98	0.46			13.44
2.03	0.05			13.39

LPE	9	San Javier	Distancia	Etapa 2	Pag.
CH	9A	Flexi Service - Ingreso	15.42	41	
			kms.	Sector 15	
Nro.	PRUEBA ESPECIAL		Kms.	Promedio	Tiempo Otorgado
9/12	San Javier Yerba Buena		6.80	46.26	20'
			kms.		

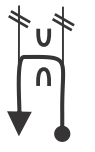
Distancia		Dirección	Información	Distancia Regresiva
Total	Parcial			
2.08	0.05	 7 <span style="float: right;">4.72</span>	Por debajo de Puente	13.34
4.70	2.62	 8 <span style="float: right;">2.10</span>	Vista Panoramica	10.72
6.80	2.10	 9 <span style="float: right;">0.00</span>	 FPE 9/12  En poste de Alambrado con letra B. <div style="border: 1px solid black; padding: 2px; width: fit-content; margin-top: 5px;">             GPS:              S 26 48 341              W 65 20 492              ALT. 723           </div>	8.62
7.12	0.32	 10	 En Árbol con letra M.	8.30
9.40	2.28	 11	RIO MUERTO	6.02
10.70	1.30	 12	 Si se sigue derecho se empalma en figura 6 de página 31 de frente.	4.72

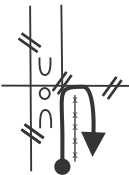

LPE	9	San Javier	Distancia	Etapa 2	Pag.
CH	9A	Flexi Service - Ingreso	15.42	Sector 15	42
Nro. PRUEBA ESPECIAL			Kms.	Promedio	Tiempo Otorgado
9/12	San Javier Yerba Buena		6.80	46.26	20'
			kms.	kms.	

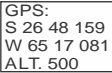
Distancia		Dirección	Información	Distancia Regresiva
Total	Parcial			
11.43	0.73	 13	POR AV. PTE PERON  Zona Urbana	3.99
12.07	0.64	 14	 Zona Urbana	3.35
14.70	2.63	 15	Cruza calle Bascary Norte  Zona Urbana	0.72
15.00	0.30	 16	Se vuelve por Av. Pte. Perón  Zona Urbana	0.42
15.31	0.31	 17	Por calle Bascary Norte e ingresa a Predio  Zona Urbana	0.11
15.42	0.11	 18	 <b>CH 9A</b> Ingreso - Flexie Service En poste de alambrado con M 	0.00

CH	9d	Parque de Servicio - Salida		Distancia	Etapa 2	Pag.
CH	10	San Pablo		11.77		43
					Sector 18	
Nro.	PRUEBA ESPECIAL		Kms.	Promedio	Tiempo Otorgado	
	ENLACE			35.31 kms.	20'	

Se repite ídem a páginas 31, 32 y 33.

LPE	10	San Pablo		Distancia	Etapa 2	Pag.
CH	11	Villa Nougues		11.26		43
					Sector 19	
Nro.	PRUEBA ESPECIAL		Kms.	Promedio	Tiempo Otorgado	
7/10	San Pablo Villa Nougues		10.22	45.04 kms.	15'	

Se repite ídem a páginas 34, 35 y 36.

LPE	11	Villa Nougues		Distancia	Etapa 2	Pag.
CH	12	San Javier		13.33		43
					Sector 20	
Nro.	PRUEBA ESPECIAL		Kms.	Promedio	Tiempo Otorgado	
8/11	Villa Nougues San Javier		10.78	31.99 kms.	25'	

Se repite ídem a páginas 37, 38 y 39.

LPE	12	San Javier		Distancia	Etapa 2	Pag.
CH	12A	Parque Cerrado Final - Ingreso		15.42		43
					Sector 21	
Nro.	PRUEBA ESPECIAL		Kms.	Promedio	Tiempo Otorgado	
9/12	San Javier Yerba Buena		6.80	46.26 kms.	20'	

Se repite ídem a páginas 40, 41 y 42.



PILOTO						
N°						
PE 1	<input type="text"/>	<input type="text"/>	<input type="text"/>	<input type="text"/>	<input type="text"/>	<input type="text"/>
PE 2	<input type="text"/>	<input type="text"/>	<input type="text"/>	<input type="text"/>	<input type="text"/>	<input type="text"/>
PE 3	<input type="text"/>	<input type="text"/>	<input type="text"/>	<input type="text"/>	<input type="text"/>	<input type="text"/>
PE 4	<input type="text"/>	<input type="text"/>	<input type="text"/>	<input type="text"/>	<input type="text"/>	<input type="text"/>
PE 5	<input type="text"/>	<input type="text"/>	<input type="text"/>	<input type="text"/>	<input type="text"/>	<input type="text"/>
PE 6	<input type="text"/>	<input type="text"/>	<input type="text"/>	<input type="text"/>	<input type="text"/>	<input type="text"/>
TIEMPO 1ra. Etapa						



PILOTO						
N°						
TIEMPO 1ra. Etapa	<input type="text"/>	<input type="text"/>	<input type="text"/>	<input type="text"/>	<input type="text"/>	<input type="text"/>
PE 7	<input type="text"/>	<input type="text"/>	<input type="text"/>	<input type="text"/>	<input type="text"/>	<input type="text"/>
PE 8	<input type="text"/>	<input type="text"/>	<input type="text"/>	<input type="text"/>	<input type="text"/>	<input type="text"/>
PE 9	<input type="text"/>	<input type="text"/>	<input type="text"/>	<input type="text"/>	<input type="text"/>	<input type="text"/>
PE 10	<input type="text"/>	<input type="text"/>	<input type="text"/>	<input type="text"/>	<input type="text"/>	<input type="text"/>
PE 11	<input type="text"/>	<input type="text"/>	<input type="text"/>	<input type="text"/>	<input type="text"/>	<input type="text"/>
PE 12	<input type="text"/>	<input type="text"/>	<input type="text"/>	<input type="text"/>	<input type="text"/>	<input type="text"/>
TIEMPO TOTAL						

