



CAMPEONATO RALLY ARGENTINO 2016



FECHA
05

LIBRO DE RUTA



MAIN SPONSORS:



AUTO OFICIAL:



SPONSORS OFICIALES:



PROVEEDORES OFICIALES:



ANEXO 1. ITINERARIO/CRONOGRAMA - MAPA

Día 1, Sección 1

INICIO (Sección 1)		SABADO 16 DE JULIO DEL 2016					
C.H.	P.E.	LUGAR	DIST. PE	DIST. ENLACE	DIST. TOTAL	TIEMPO OTORGADO	PASO 1° AUTO
0		TAFI DEL VALLE - Parque de Servicio (Salida)					10:30
RZ		TAFI DEL VALLE (a los 0,02 del ch 0)					
1		Km hasta llegar al siguiente reabastecimiento	36,90	34,38	71,28		
1		PE 1 "PIRELLI" COSTA 1 - COSTA 2	7,95	1,12	1,12	00:10	10:40
2				10,89	18,84	00:25	11:08
3		PE 2 "BODEGAS LORCA" CASAS VIEJAS - SAN C.	9,05	7,92	16,97	00:22	11:33
PE 3 "OPTITECH" RODEO GRANDE - EL POTRERIL		19,90					11:36
3A		TAFI DEL VALLE - Parque de Servicio INGRESO		14,45	34,35	00:45	12:21
3B		Parque Servicio INGRESO				00:20	12:21
		PARQUE DE SERVICIO "A" - TAFI DEL VALLE	36,90	34,38	71,28	00:30	
3C		Servicio SALIDA / Reagrupamiento INGRESO					12:51
		REAGRUPAMIENTO - MAXIMO				00:35	

Día 1, Sección 2

INICIO (Sección 2)		SABADO 16 DE JULIO DEL 2016		
3D	TAFI DEL VALLE - Parque de Servicio (Salida)			13:26
RZ	TAFI DEL VALLE (a los 0,02 del ch 3D)			
2	Km hasta llegar al siguiente reabastecimiento	36,90	19,93	56,83
4	PE 4 "PIRELLI" COSTA 1 - COSTA 2	7,95	1,12	00:10
5	PE 5 "BODEGAS LORCA" CASAS VIEJAS - SAN CAY	9,05	10,89	18,84
6	PE 6 "OPTITECH" RODEO GRANDE - EL POTRERILLO	19,90	7,92	16,97
6A	TAFI DEL VALLE - Zona Técnica INGRESO		14,45	14,45
	ZONA TECNICA			00:10
6B	Zona Técnica SALIDA - Flexi Service INGRESO			15:27
	FLEXI SERVICE - MAXIMO			00:45
6C	Flexie Service SALIDA - Parque Servicio INGRESO			15:27
	PARQUE DE SERVICIO "B" - TAFI DEL VALLE	36,90	34,38	51,38
6D	Servicio SALIDA - Parque Cerrado INGRESO			16:12
REAGRUPAMIENTO NOCTURNO				
TOTALES SABADO		73,80	68,76	122,66

Día 2, Sección 3

INICIO (Sección 5)		DOMINGO 17 DE JULIO DEL 2016			
6E	Parque de Cerrado SALIDA - Parque de Servicio	INGRESO			08:30
	PARQUE DE SERVICIO "C" - TAFI DEL VALLE	0,00	0,00	0,00	00:25
6F	Parque de Servicio	SALIDA			08:55
RZ	TAFI DEL VALLE (a los 0,02 del ch 6G)				
3	Km hasta llegar al siguiente reabastecimiento	26,35	35,89	62,24	
7		2,92	2,92	00:10	09:05
8	PE 7 "ELAION" LA VILLA - COSTA 1	5,75	21,15	26,90	00:30
					09:08
9	PE 8 "EDOX" EL RINCON - EL RINCON	11,55	8,02	19,57	00:25
					10:06
	PE 9 "BODEGAS LORCA" CASAS VIEJAS - SAN C.	9,05			10:09
9A	TAFI DEL VALLE - Parque de Servicio	INGRESO	3,80	12,85	00:20
	FLEXI SERVICE - MAXIMO				00:20
9B	Parque Servicio	INGRESO			10:29
	PARQUE DE SERVICIO "D" - TAFI DEL VALLE	26,35	35,89	62,24	00:30
9C	Servicio SALIDA / Reagrupamiento	INGRESO			10:59
	REAGRUPAMIENTO - MAXIMO				00:35







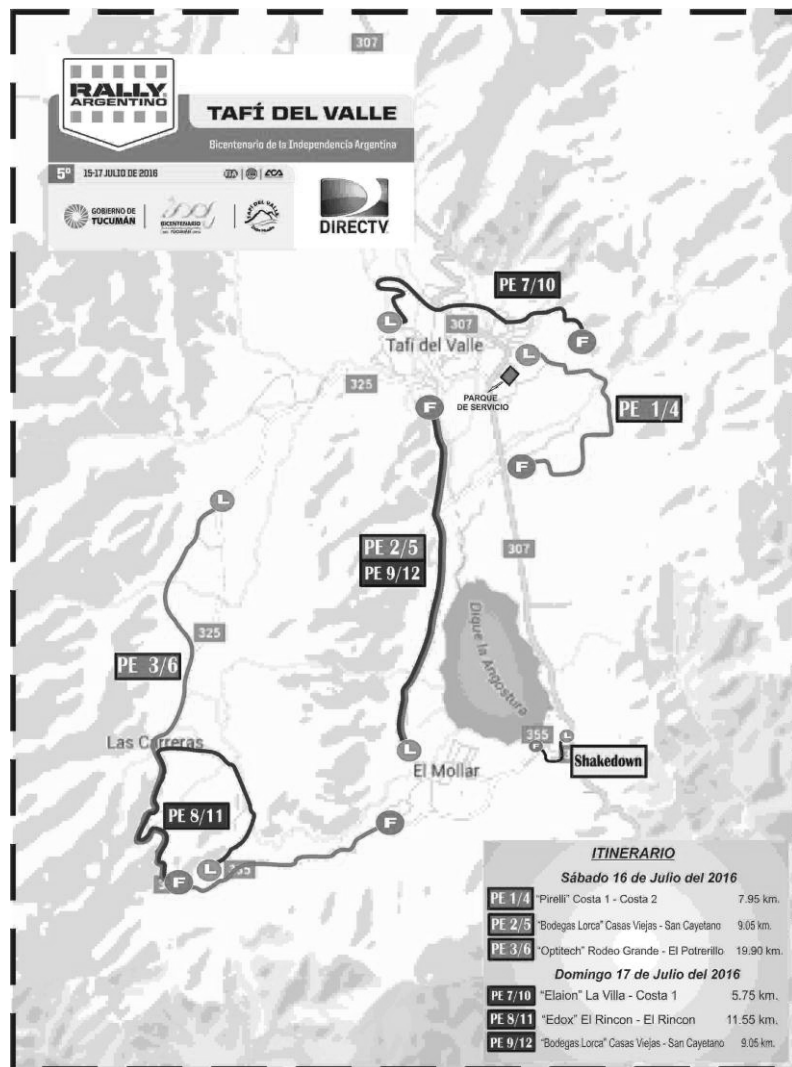







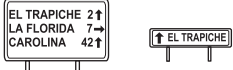

Día 2, Sección 4













INICIO (Sección 6)		DOMINGO 17 DE JULIO DEL 2016			
9D	TAFIDEL VALLE - Parque de Servicio (Salida)				11:34
RZ	TAFIDEL VALLE (a los 0,02 del ch 9D)				
4	Km hasta llegar al siguiente reabastecimiento	26,35	35,87	62,22	
10		2,92	2,92	00:10	11:44
	PE 10 "ELAION" LA VILLA - COSTA 1	5,75			11:47
11		21,15	26,90	00:30	12:17
	PE 11 "EDOX" EL RINCON - EL RINCON	11,55			12:20
12		8,02	19,57	00:25	12:45
	PE 12 "BODEGAS LORCA" CASAS VIEJAS - SAN C.	9,05			12:48
12A	TAFIDEL VALLE - Podio Final	3,80	12,85	00:20	13:08
TOTALES DOMINGO		52,70	71,78	124,48	
RESUMEN DE LA COMPETENCIA					
	PE	ENLACE TOTAL	%PE		
Sábado	73,80	68,76	122,66	58,5	
Domingo	52,70	71,78	124,48	41,5	
Total del Rally	126,50	140,54	247,14	100,00	

Mapa





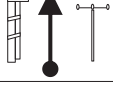







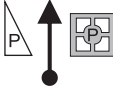

Simbolo	Significado
	Control Horario
	Largada Prueba Especial
	Final Prueba Especial
	Stop
	Radio
	Ambulancia
	Bomberos
	Precaución
	Peligro
	Muy peligroso
	Atención Angosto
	Señal de Celular
	Sin Señal de Celular



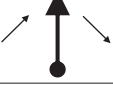

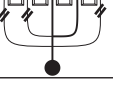

Simbolo	Significado
	Lomada sobre asfalto
	Lomo o lomada sobre tierra
	Vado o Baden Seco
	Vado o Baden con Cruce de Agua
	Corte con Cruce de Agua
	Corte Seco
	Cartel rutero indicador 
	Dirección a seguir Número de figura
	No utilizar lo cruzado con diagonales
	Camino Asfaltado
	Camino de tierra / ripio
	Prueba Especial Número de figura Distancia Regresiva
	Puente
	Alcantarilla
	Guardaganado
	Ingresa por tranquera

Simbolo	Significado
	Vías ferrocarril
	Parques de Servicio
	Alambrado
	Arbol
	Cementerio
	Casa
	Escuela
	Iglesia o Capilla
	Hospital
	Piedra / Pirca
	Postes de electricidad
	Refugio
	Estación de Servicio

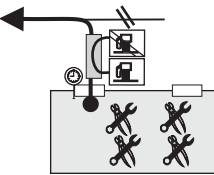

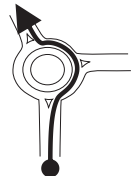
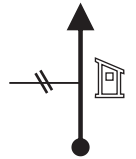
||

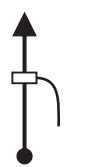
Simbolo	Significado
	Sendero
	Mojón indicador Kilometraje de ruta
	Semaforo
	Plaza / Plazoleta
	Hotel / Hostería
	Fabrica
	Tranquera en alambrado lateral
	Antena
	Gruta
	Camino en ascenso o Camino en descenso
	Camino sinuoso
	Estación de Peaje
	Alambrado olimpico





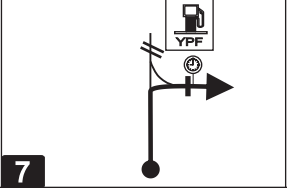

CH	Tafí del Valle - Parque de Servicio	Distancia	Etapa	Pag.
CH	Dique La Angostura - Shakedown	9.40 kms.	Sector	III
Nro.	PRUEBA ESPECIAL	Kms.	Promedio	Tiempo Otorgado
	ENLACE		kms.	

Distancia		Dirección	Información	Distancia Regresiva
Total	Parcial			
0.00	0.00	 1	 CH Sh Salida Parque de Servicio Complejo Deportivo Democracia Continúa por Rp 307  Zona de Reabastecimiento de Combustible GPS: S 26 51 378 W 65 41 633 ALT. 1969	9.40
0.39	0.39	 2		9.01
2.49	2.10	 3	 A la Izquierda Ingreso a FPE 1 y 4	6.91
3.92	1.43	 4	<div style="border: 1px solid black; padding: 5px; display: inline-block;">Punta de la Pirca</div>	5.48
7.95	4.03	 5	<div style="border: 1px solid black; padding: 5px; display: inline-block;"> S. M. de Tucumán  El Mollar Retorno </div>	1.45
8.20	0.25	 6		1.20

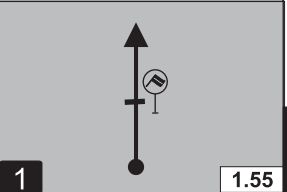

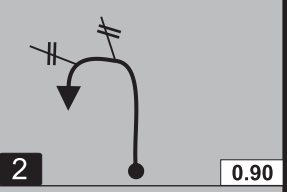
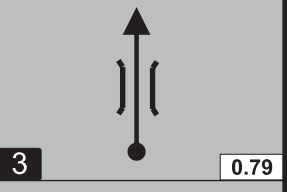
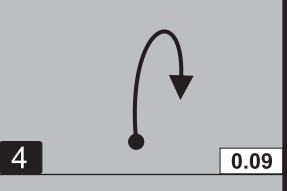
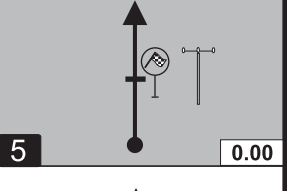

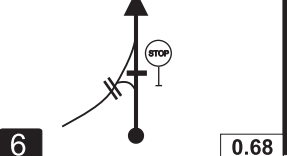

CH	Tafí del Valle - Parque de Servicio	Distancia	Etapa	Pag.
CH	Dique La Angostura - Shakedown	9.40 kms.	Sector	IV
Nro.	PRUEBA ESPECIAL	Kms.	Promedio	Tiempo Otorgado
	ENLACE		kms.	

Distancia		Dirección	Información	Distancia Regresiva
Total	Parcial			
9.40	1.20		 CH Sh En Cuanto deja Rp N°307	0.00

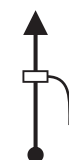
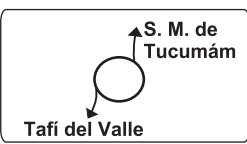
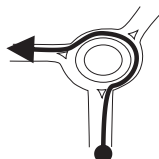

LPE	Shakedown		Distancia	Etapa	Pag.
CH	Tafí del Valle - Parque de Servicio		11.85	Sector	V
Nro.	PRUEBA ESPECIAL	Kms.	Promedio	Tiempo Otorgado	
	SHAKEDOWN	1.55			

Distancia		Dirección	Información	Distancia Regresiva
Total	Parcial			
0.00	0.00		 LPT  Donde comienza tierra GPS: S 26 56 137 W 65 40 674 ALT. 1868 <small>1er. Auto 14:00 hs.</small>	11.85
0.65	0.65			11.20
0.76	0.11			11.09
1.46	0.70			10.39
1.55	0.09		 FPT  En poste de madera. GPS: S 26 56 252 W 65 41 304 ALT. 1913	10.30
1.63	0.08		 STOP Antes de Asfalto	10.22



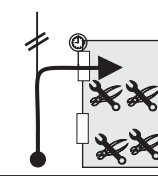

LPE	Shakedown		Distancia	Etapa	Pag.
CH	Tafí del Valle - Parque de Servicio		11.85	Sector	VI
			kms.		
Nro.	PRUEBA ESPECIAL	Kms.	Promedio	Tiempo Otorgado	
	SHAKEDOWN	1.55			

Distancia		Dirección	Información	Distancia Regresiva
Total	Parcial			
2.24	0.61	 7	VERTEDERO	9.61
3.20	0.96	 8		8.65
3.30	0.10	 9	 Si sigue derecho vuelve a Largada de Shakedown.	8.55
3.53	0.23	 10		8.32
7.44	3.91	 11	Punta de la Pirca	4.41
10.45	3.01	 12	Bienvenido a Tafí del Valle	1.40

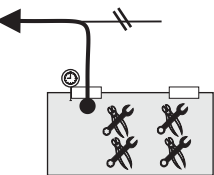

LPE	Shakedown		Distancia	Etapa	Pag.
CH	Tafí del Valle - Parque de Servicio		11.85 kms.	Sector	VII
Nro.	PRUEBA ESPECIAL	Kms.	Promedio	Tiempo Otorgado	
	SHAKEDOWN	1.55			

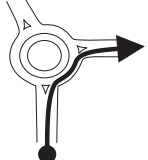
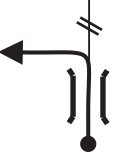
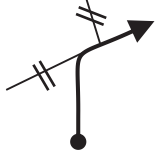
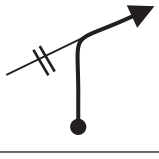
Distancia		Dirección	Información	Distancia Regresiva
Total	Parcial			
11.27	0.82		Cruza ingreso a Tafí Continúa por Rp N°307	0.58
11.85	0.58		 CH Ingreso - Parque de Service Complejo Deportivo Democracia Deja Rp N°307 GPS: S 26 51 327 W 65 41 589 ALT. 1979	0.00





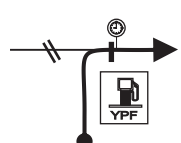

CH	Tafí del Valle - Parque de Servicio	Distancia	Etapa	Pag.
CH	Parque de Largada	2.17 kms.	Sector	VIII
Nro.	PRUEBA ESPECIAL	Kms.	Promedio	Tiempo Otorgado
	ENLACE		kms.	

Distancia		Dirección	Información	Distancia Regresiva
Total	Parcial			
0.00	0.00	 1	 CH Salida Parque de Servicio Complejo Deportivo Democracia Continúa por Rp 307 GPS: S 26 51 378 W 65 41 633 ALT. 1969	2.17
0.37	0.37	 2	Ingres a Tafí del Valle	1.80
0.90	0.53	 3		1.27
0.99	0.09	 4		1.18
1.84	0.85	 5		0.33
2.00	0.16	 6	Piso Adoquinado	0.17

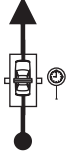

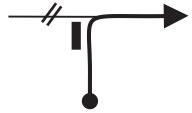
CH	Tafí del Valle - Parque de Servicio	Distancia 2.17 kms.	Etapa	Pag. IX
CH	Parque de Largada		Sector	
Nro.	PRUEBA ESPECIAL	Kms.	Promedio	Tiempo Otorgado
	ENLACE		kms.	

Distancia		Dirección	Información	Distancia Regresiva
Total	Parcial			
2.17	0.17		 CH Ingreso - Parque de Largada Por calle Av. Pte. Perón	0.00
		7		

CH	Rampa de Largada Simbólica	Distancia	Etapa	Pag.
CH	Tafí del Valle - Parque de Servicio	2.26 kms.	Sector	X
Nro.	PRUEBA ESPECIAL	Kms.	Promedio	Tiempo Otorgado
	ENLACE		kms.	

Distancia		Dirección	Información	Distancia Regresiva
Total	Parcial			
0.00	0.00	 1	 LSP Largada Simbólica Promocional TAFI DEL VALLE GPS: S 26 51 250 W 65 42 544 ALT. 1993	2.26
0.14	0.14	 2		2.12
0.27	0.13	 3	Por Av. Gob. Critto	1.99
0.85	0.58	 4		1.41
1.15	0.30	 5		1.11
1.60	0.45	 6	<div style="border: 1px solid black; padding: 5px;"> S. M. de Tucumán → El Mollar → ← Amancha </div>	0.66

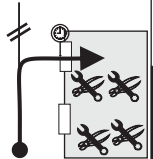
CH	Rampa de Largada Simbólica	Distancia	Etapa	Pag.
CH	Tafí del Valle - Parque de Servicio	2.26 kms.	Sector	XI
Nro.	PRUEBA ESPECIAL	Kms.	Promedio	Tiempo Otorgado
	ENLACE		kms.	

Distancia		Dirección	Información	Distancia Regresiva
Total	Parcial			
2.26	0.66		 CH Ingreso - Parque de Service Complejo Deportivo Democracia Deja Rp N°307 GPS: S 26 51 327 W 65 41 589 ALT. 1979	0.00
		7		









Día 1- Sección 1

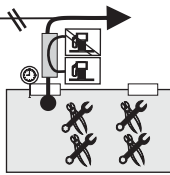



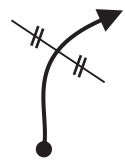

Etapas 1

16 de Julio del 2016

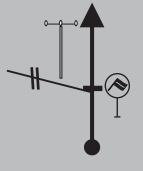

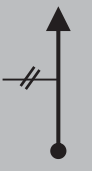

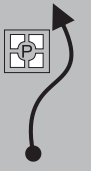
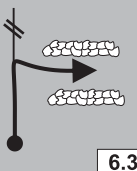
CH	0	Parque de Servicio - Salida	Distancia	Etapa 1	Pag.
CH	1	Costa 1	1.12 kms.	Sector 1	1
Nro.		PRUEBA ESPECIAL	Kms.	Promedio	Tiempo Otorgado
		ENLACE		6.72 kms.	10'

Distancia		Dirección	Información	Distancia Regresiva
Total	Parcial			
0.00	0.00	 1	 CH 0  Salida Parque de Servicio Complejo Deportivo Democracia Continúa por Rp 307 Zona de Reabastecimiento de Combustible GPS: S 26 51 378 W 65 41 633 ALT. 1969	1.12
0.50	0.50	 2	DEJA RP N° 307	0.62
0.88	0.38	 3		0.24
1.12	0.24	 4	 CH 1 Frente a tranquera de EL PUESTO CABALGATA 1er. Auto 10:40 hs.	0.00

LPE	1	Costa 1	Distancia	Etapa 1	Pag.
CH	2	Casas Viejas	18.84	Sector 2	2
			kms.		
Nro.	PRUEBA ESPECIAL		Kms.	Promedio	Tiempo Otorgado
1/4	Costa 1	Costa 2	7.95	45.21	25'
				kms.	

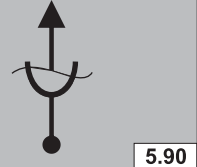
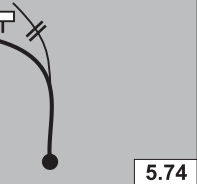
Distancia		Dirección	Información	Distancia Regresiva
Total	Parcial			
0.00	0.00	 1 7.95	 LPE 1/4 En poste de electricidad con Letra M. <div style="display: flex; justify-content: space-between; font-size: small;"> <div> GPS: S 26 51 209 W 65 41 166 ALT. 2001 </div> <div> 1er. Auto 10:43 hs </div> </div>	18.84
0.10	0.10	 2 7.85	LA GUADALUPE POSADA	18.74
0.60	0.50	 3 7.35	 A la Izquierda Ingreso a FPE 7 y 10	18.24
1.39	0.79	 4 6.56	PLAZA EVA PERON	17.45
1.58	0.19	 5 6.37		17.26
1.87	0.29	 6 6.08		16.97

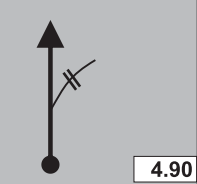
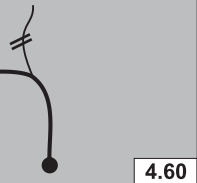





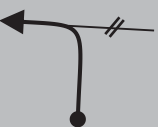

LPE	1	Costa 1	Distancia	Etapa 1	Pag.
CH	2	Casas Viejas	18.84 kms.	Sector 2	3
Nro.	PRUEBA ESPECIAL		Kms.	Promedio	Tiempo Otorgado
1/4	Costa 1 Costa 2	7.95	45.21 kms.	25'	

Distancia		Dirección	Información	Distancia Regresiva
Total	Parcial			
2.05	0.18		A° NATURAL	16.79
2.21	0.16		Rosalinda →	16.63
2.30	0.09		Continúa por Camino Consolidado	16.54
3.05	0.75			15.79
3.35	0.30			15.49
3.59	0.24			15.25





LPE	1	Costa 1	Distancia	Etapa 1	Pag.
CH	2	Casas Viejas	18.84 kms.	Sector 2	4
Nro.	PRUEBA ESPECIAL		Kms.	Promedio	Tiempo Otorgado
1/4	Costa 1 Costa 2	7.95	45.21 kms.	25'	

Distancia		Dirección	Información	Distancia Regresiva
Total	Parcial			
3.95	0.36	 13 4.00		14.89
4.05	0.10	 14 3.90		14.79
4.17	0.12	 15 3.78		14.67
4.53	0.36	 16 3.42		14.31
4.64	0.11	 17 3.31		14.20
6.13	1.49	 18 1.82		12.71



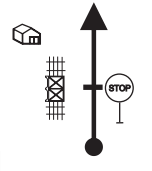

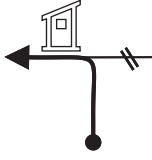
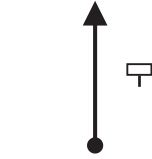
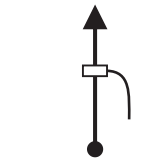
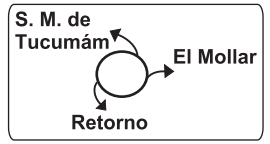

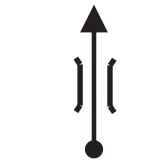

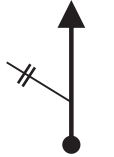

LPE	1	Costa 1	Distancia	Etapa 1	Pag.
CH	2	Casas Viejas	18.84	Sector 2	5
			kms.		
Nro.	PRUEBA ESPECIAL		Kms.	Promedio	Tiempo Otorgado
1/4	Costa 1	Costa 2	7.95	45.21	25'
				kms.	

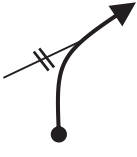
Distancia		Dirección	Información	Distancia Regresiva
Total	Parcial			
6.29	0.16	 19 1.66		12.55
6.66	0.37	 20 1.29		12.18
7.05	0.39	 21 0.90		11.79
7.21	0.16	 22 0.74		11.63
7.68	0.47	 23 0.27		11.16
7.95	0.27	 24 0.00	 FPE 1/4  En piedra con letra B. GPS: S 26 52 576 W 65 41 391 ALT. 1950	10.89











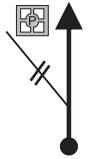

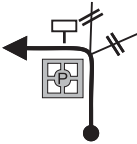
LPE	1	Costa 1	Distancia	Etapa 1	Pag.
CH	2	Casas Viejas	18.84 kms.	Sector 2	6
Nro.	PRUEBA ESPECIAL		Kms.	Promedio	Tiempo Otorgado
1/4	Costa 1 Costa 2	7.95	45.21 kms.	25'	

Distancia		Dirección	Información	Distancia Regresiva
Total	Parcial			
8.22	0.27	 25	 En tranquera	10.62
8.29	0.07	 26	Por Rp N° 307	10.55
9.73	1.44	 27	Punta de la Pirca	9.11
13.75	4.02	 28		5.09
14.00	0.25	 29		4.84
15.12	1.12	 30	VERTEDERO	3.72

LPE	1	Costa 1	Distancia	Etapa 1	Pag.
CH	2	Casas Viejas	18.84	Sector 2	7
			kms.		
Nro.	PRUEBA ESPECIAL		Kms.	Promedio	Tiempo Otorgado
1/4	Costa 1	Costa 2	7.95	45.21	25'
			kms.	kms.	

Distancia		Dirección	Información	Distancia Regresiva
Total	Parcial			
16.19	1.07	 31		2.65
16.53	0.34	 32	<div style="border: 1px solid black; padding: 2px; display: inline-block;">El Mollar</div> <i>i</i> A la Izquierda LPE N° 8 y 11 FPE N° 8 y 11 FPE N° 3 Y 6	2.31
16.76	0.23	 33	Por Av. Los Menhires  Zona Urbana	2.08
17.37	0.61	 34	 Zona Urbana	1.47
17.65	0.28	 35	 Zona Urbana	1.19
17.70	0.05	 36	 Zona Urbana	1.14







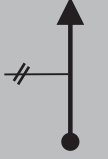

LPE	1	Costa 1	Distancia	Etapa 1	Pag.
CH	2	Casas Viejas	18.84	Sector 2	8
			kms.		
Nro.	PRUEBA ESPECIAL		Kms.	Promedio	Tiempo Otorgado
1/4	Costa 1	Costa 2	7.95	45.21	25'
				kms.	

Distancia		Dirección	Información	Distancia Regresiva
Total	Parcial			
18.00	0.30	 37	 Zona Urbana	0.84
18.11	0.11	 38	Casas Viejas  Zona Urbana	0.73
18.29	0.18	 39	 Zona Urbana	0.55
18.48	0.19	 40	 Zona Urbana	0.36
18.75	0.27	 41	 Zona Urbana	0.09
18.84	0.09	 42	 CH 2 Frente a Cartel de COMUNA INDÍGENA CASAS VIEJAS 	0.00









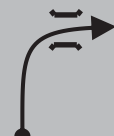

LPE	2	Casas Viejas	Distancia	Etapa 1	Pag.
CH	3	Rodeo Grande	16.97	Sector 3	9
			kms.		
Nro.	PRUEBA ESPECIAL		Kms.	Promedio	Tiempo Otorgado
2/5	Casas Viejas San Cayetano		9.05	46.28	22'
			kms.	kms.	

Distancia		Dirección	Información	Distancia Regresiva								
Total	Parcial											
0.00	0.00	 1 9.05	LPE 2/5 En piedra con Letra B. <table border="1"> <tr> <td>GPS:</td> <td></td> </tr> <tr> <td>S 26 56 282</td> <td></td> </tr> <tr> <td>W 65 42 930</td> <td>1er. Auto</td> </tr> <tr> <td>ALT. 1950</td> <td>11:11 hs</td> </tr> </table>	GPS:		S 26 56 282		W 65 42 930	1er. Auto	ALT. 1950	11:11 hs	16.97
GPS:												
S 26 56 282												
W 65 42 930	1er. Auto											
ALT. 1950	11:11 hs											
0.23	0.23	 2 8.82		16.74								
0.42	0.19	 3 8.63		16.55								
0.62	0.20	 4 8.43		16.35								
0.71	0.09	 5 8.34		16.26								
1.20	0.49	 6 7.85		15.77								







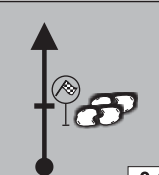

LPE	2	Casas Viejas	Distancia	Etapa 1	Pag.
CH	3	Rodeo Grande	16.97 kms.	Sector 3	10
Nro.	PRUEBA ESPECIAL		Kms.	Promedio	Tiempo Otorgado
2/5	Casas Viejas San Cayetano		9.05	46.28 kms.	22'

Distancia		Dirección	Información	Distancia Regresiva
Total	Parcial			
1.35	0.15	 7 7.70		15.62
1.82	0.47	 8 7.23		15.15
2.80	0.98	 9 6.25		14.17
2.85	0.05	 10 6.20	Vado Natural 	14.12
3.22	0.37	 11 5.83	Vado Natural 	13.75
4.23	1.01	 12 4.82		12.74



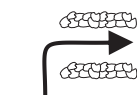



LPE	2	Casas Viejas	Distancia	Etapa 1	Pag.
CH	3	Rodeo Grande	16.97	Sector 3	11
			kms.		
Nro.	PRUEBA ESPECIAL		Kms.	Promedio	Tiempo Otorgado
2/5	Casas Viejas San Cayetano		9.05	46.28	22'
			kms.	kms.	

Distancia		Dirección	Información	Distancia Regresiva
Total	Parcial			
4.85	0.62	  13 4.20		12.12
5.20	0.35	  14 3.85		11.77
5.46	0.26	  15 3.59	VEEDOR	11.51
6.15	0.69	  16 2.90		10.82
6.29	0.14	  17 2.76		10.68
6.62	0.33	  18 2.43		10.35







LPE	2	Casas Viejas	Distancia	Etapa 1	Pag.
CH	3	Rodeo Grande	16.97	Sector 3	12
			kms.		
Nro.	PRUEBA ESPECIAL		Kms.	Promedio	Tiempo Otorgado
2/5	Casas Viejas San Cayetano		9.05	46.28	22'
			kms.		

Distancia		Dirección	Información	Distancia Regresiva
Total	Parcial			
9.05	2.43	 19 0.00	 FPE 2/5  En piedra con letra B en verde. GPS: S 26 51 868 W 65 42 584 ALT. 1941	7.92
9.24	0.19	 20	 Frente a casa con pirca	7.73
9.29	0.05	 21		7.68
9.66	0.37	 22		7.31
9.78	0.12	 23		7.19
10.01	0.23	 24	Por Rn N°325 	6.96



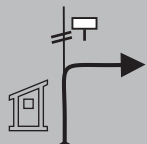

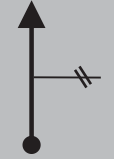
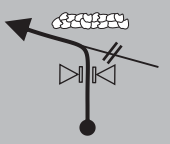
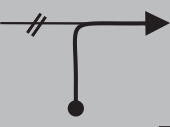



LPE	2	Casas Viejas	Distancia	Etapa 1	Pag.
CH	3	Rodeo Grande	16.97 kms.	Sector 3	13
Nro.	PRUEBA ESPECIAL		Kms.	Promedio	Tiempo Otorgado
2/5	Casas Viejas San Cayetano		9.05	46.28 kms.	22'

Distancia		Dirección	Información	Distancia Regresiva
Total	Parcial			
12.59	2.58	 25	Comienza Tierra	4.38
13.65	1.06	 26		3.32
13.96	0.31	 27		3.01
14.75	0.79	 28		2.22
14.82	0.07	 29	El Rodeo	2.15
16.97	2.15	 30	 CH 3 En poste de cemento con letra M. 1er. Auto 11:33 hs.	0.00





LPE	3	Rodeo Grande	Distancia	Etapa 1	Pag.
CH	3a	Flexi Service - Ingreso	34.35 kms.	Sector 4	14
Nro.	PRUEBA ESPECIAL		Kms.	Promedio	Tiempo Otorgado
3/6	Rodeo Grande El Potrerillo		19.90	45.80 kms.	45'

Distancia		Dirección	Información	Distancia Regresiva
Total	Parcial			
0.00	0.00	 1 19.90	 LPE 3/6  En Árbol con cinta. GPS: S 26 53 001 W 65 45 607 ALT. 2218 1er. Auto 11:36 hs	34.35
0.22	0.22	 2 19.68	 EEAOC 3 Deja Camino Ancho	34.13
1.22	1.00	 3 18.68		33.13
1.35	0.13	 4 18.55		33.00
1.43	0.08	 5 18.47		32.92
1.73	0.30	 6 18.17		32.62





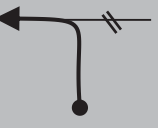

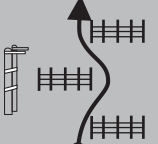

LPE	3	Rodeo Grande	Distancia	Etapa 1	Pag.
CH	3a	Flexi Service - Ingreso	34.35 kms.	Sector 4	15
Nro.	PRUEBA ESPECIAL		Kms.	Promedio	Tiempo Otorgado
3/6	Rodeo Grande El Potrerillo		19.90	45.80 kms.	45'

Distancia		Dirección	Información	Distancia Regresiva
Total	Parcial			
1.91	0.18	 7 17.99	YAYA CUNAWASI	32.44
2.15	0.24	 8 17.75		32.20
2.28	0.13	 9 17.62		32.07
3.60	1.32	 10 1630		30.75
3.65	0.05	 11 16.25	Vado Natural 	30.70
3.85	0.20	 12 16.05	Angosto 	30.50



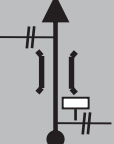



LPE	3	Rodeo Grande	Distancia	Etapa 1	Pag.
CH	3a	Flexi Service - Ingreso	34.35 kms.	Sector 4	16
Nro.	PRUEBA ESPECIAL		Kms.	Promedio	Tiempo Otorgado
3/6	Rodeo Grande El Potrerillo		19.90	45.80 kms.	45'

Distancia		Dirección	Información	Distancia Regresiva
Total	Parcial			
4.45	0.60	 13 15.45		29.90
4.59	0.14	 14 15.31		29.76
4.85	0.26	 15 15.05		29.50
5.06	0.21	 16 14.84		29.29
5.33	0.27	 17 14.57		29.02
5.84	0.51	 18 14.06	Por camino Ancho	28.51

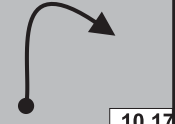
LPE	3	Rodeo Grande	Distancia	Etapa 1	Pag.
CH	3a	Flexi Service - Ingreso	34.35 kms.	Sector 4	17
Nro.	PRUEBA ESPECIAL		Kms.	Promedio	Tiempo Otorgado
3/6	Rodeo Grande El Potrerillo		19.90	45.80 kms.	45'

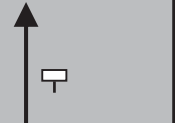
Distancia		Dirección	Información	Distancia Regresiva
Total	Parcial			
6.75	0.91	 19 13.15		27.60
7.10	0.35	 20 12.80	Chicana N° 1 Sobre el Camino Frente a poste doble de Cemento.	27.25
7.77	0.67	 21 12.13	Escuela N° 22	26.58
8.15	0.38	 22 11.75	Deja camino Ancho.	26.20
8.26	0.11	 23 11.64	Vuelve a camino Ancho.	26.09
8.60	0.34	 24 11.30	El Rincón 4 El Mollar 19  Se une con PE N° 8 y 11  Rescate Médico  Comunicación GPS: S 26 56 039 W 65 46 580 ALT. 2343	25.75







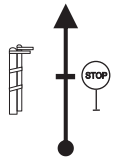

LPE	3	Rodeo Grande	Distancia	Etapa 1	Pag.
CH	3a	Flexi Service - Ingreso	34.35 kms.	Sector 4	18
Nro.	PRUEBA ESPECIAL		Kms.	Promedio	Tiempo Otorgado
3/6	Rodeo Grande El Potrerillo		19.90	45.80 kms.	45'

Distancia		Dirección	Información	Distancia Regresiva
Total	Parcial			
9.73	1.13	 25 10.17	Curva Angosta  Comienza a costear Cerro	24.62
10.24	0.51	 26 9.66	Mirador EL CONDOR	24.11
12.38	2.14	 27 7.52	El Rincón	21.97
14.00	1.62	 28 5.90		20.35
14.37	0.37	 29 5.53		19.98
14.82	0.45	 30 5.08	Chicana N° 2 Fuera del Camino Por detrás de Tacho	19.53







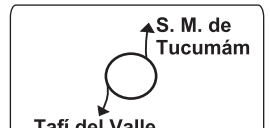

LPE	3	Rodeo Grande	Distancia	Etapa 1	Pag.
CH	3a	Flexi Service - Ingreso	34.35 kms.	Sector 4	19
Nro.	PRUEBA ESPECIAL		Kms.	Promedio	Tiempo Otorgado
3/6	Rodeo Grande El Potrerillo		19.90	45.80 kms.	45'

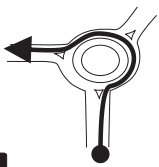
Distancia		Dirección	Información	Distancia Regresiva
Total	Parcial			
15.10	0.28	 31	A la Izquierda Largada PE N° 8 y 11	19.25
16.00	0.90	 32	Chicana N° 3 Sobre el Camino Frente a poste de alambrado con cinta.	18.35
16.95	0.95	 33	<div style="border: 1px solid black; padding: 2px; display: inline-block;">Zona Urbana</div>	17.40
17.05	0.10	 34		17.30
18.45	1.40	 35	<div style="border: 1px solid black; padding: 2px; display: inline-block;">← HOSTAL EL POTRERILLO</div>	15.90
19.90	1.45	 36	FPE 3/6 En entrada a casa con guardaganado en puerta. <div style="border: 1px solid black; padding: 2px; font-size: small;"> GPS: S 26 57 015 W 65 43 387 ALT. 2111 </div>	14.45

LPE	3	Rodeo Grande	Distancia	Etapa 1	Pag.
CH	3a	Flexi Service - Ingreso	34.35 kms.	Sector 4	20
Nro.	PRUEBA ESPECIAL		Kms.	Promedio	Tiempo Otorgado
3/6	Rodeo Grande El Potrerillo		19.90	45.80 kms.	45'

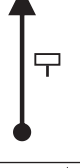
Distancia		Dirección	Información	Distancia Regresiva
Total	Parcial			
20.25	0.35	 37	 En poste de doble de Cemento con número 1.	14.10
21.38	1.13	 38		12.97
23.17	1.79	 39		11.18
23.45	0.28	 40	Por Rp. N° 325 	10.90
24.80	1.35	 41	VERTEDERO	9.55
25.73	0.93	 42		8.62

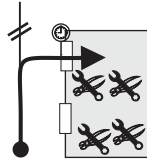
LPE	3	Rodeo Grande	Distancia	Etapa 1	Pag.
CH	3a	Flexi Service - Ingreso	34.35 kms.	Sector 4	21
Nro.	PRUEBA ESPECIAL		Kms.	Promedio	Tiempo Otorgado
3/6	Rodeo Grande El Potrerillo		19.90	45.80 kms.	45'

Distancia		Dirección	Información	Distancia Regresiva
Total	Parcial			
25.83	0.10	 43	Por Rp N°307	8.52
26.10	0.27	 44		8.25
30.00	3.90	 45	Punta de la Pirca	4.35
33.03	3.03	 46	Bienvenido a Tafí del Valle	1.32
33.80	0.77	 47	Cruza ingreso a Tafí Continúa por Rp N°307	0.55
34.35	0.55	 48	 CH 3A Ingreso - Parque de Service Complejo Deportivo Democracia Deja Rp N°307 GPS: S 26 51 327 W 65 41 589 ALT. 1979	0.00

CH	3D	Parque de Servicio - Salida	Distancia	Etapa 1	Pag.
CH	4	Costa 1	1.12 kms.	Sector 6	22
Nro.	PRUEBA ESPECIAL		Kms.	Promedio	Tiempo Otorgado
	ENLACE			6.72 kms.	10'

Se repite ídem a páginas 1.

LPE	4	Costa 1	Distancia	Etapa 1	Pag.
CH	5	Casas Viejas	18.84 kms.	Sector 7	
Nro.	PRUEBA ESPECIAL		Kms.	Promedio	Tiempo Otorgado
1/4	Costa 1 Costa 2	7.95		45.21 kms.	25'

Se repite ídem a páginas 2, 3, 4, 5, 6, 7 y 8.

LPE	5	Casas Viejas	Distancia	Etapa 1	Pag.
CH	6	Rodeo Grande	16.97 kms.	Sector 8	
Nro.	PRUEBA ESPECIAL		Kms.	Promedio	Tiempo Otorgado
2/5	Casas Viejas San Cayetano	9.05		46.28 kms.	22'

Se repite ídem a páginas 9, 10, 11, 12 y 13.

LPE	6	Rodeo Grande	Distancia	Etapa 1	Pag.
CH	6a	Zona Técnica - Ingreso	34.35 kms.	Sector 9	
Nro.	PRUEBA ESPECIAL		Kms.	Promedio	Tiempo Otorgado
3/6	Rodeo Grande El Potrerillo	19.90		45.80 kms.	45'

Se repite ídem a páginas 14, 15, 16, 17, 18, 19, 20 y 21.

LA ZONA TÉCNICA SE ENCONTRARÁ EN LA FIGURA 48 DE LA PAG. 21, EN CUANTO DEJA RP N° 307.











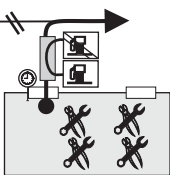

Día 2- Sección 3





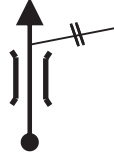





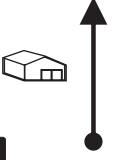

Etapas 2

17 de Julio del 2016







CH 6d	Parque de Servicio - Salida	Distancia	Etapa 2	Pag.
CH 7	La Villa	2.92	Sector 12	23
Nro.	PRUEBA ESPECIAL	Kms.	Promedio	Tiempo Otorgado
	ENLACE		17.52	10'
		kms.	kms.	

Distancia		Dirección	Información	Distancia Regresiva
Total	Parcial			
0.00	0.00	 1	 CH 6F  Salida Parque de Servicio Complejo Deportivo Democracia Continúa por Rp 307  Zona de Reabastecimiento de Combustible GPS: S 26 51 378 W 65 41 633 ALT. 1969	2.92
0.50	0.50	 2		2.42
0.75	0.25	 3	 ← Tafí del Valle (ctro) ↑ Amicha ↑ Quilmes	2.17
0.90	0.15	 4	Deja Rp N° 307 Continúa por Avenida Juan Calchaqui	2.02
1.15	0.25	 5		1.77
1.95	0.80	 6	 Zona Urbana	0.97

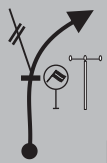

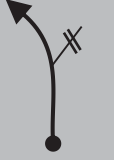

CH 6d	Parque de Servicio - Salida	Distancia	Etapa 2	Pag.
CH 7	La Villa	2.92	Sector 12	24
Nro. PRUEBA ESPECIAL		Promedio	Tiempo Otorgado	
ENLACE		17.52	10'	
		kms.		

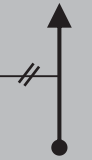
Distancia		Dirección	Información	Distancia Regresiva
Total	Parcial			
2.21	0.26	 7	 Zona Urbana	0.71
2.35	0.14	 8	MUNICIPALIDAD DE TAFI DEL VALLE  Zona Urbana	0.57
2.54	0.19	 9	 Zona Urbana	0.38
2.86	0.32	 10	 Zona Urbana	0.06
2.90	0.04	 11	 Zona Urbana	0.02
2.92	0.02	 12	 CH 7 En poste medidor de consumo. 	0.00

LPE	7	La Villa	Distancia	Etapa 2	Pag.
CH	8	El Rincón	26.90	Sector 13	25
			kms.		
Nro.	PRUEBA ESPECIAL		Kms.	Promedio	Tiempo Otorgado
7/10	La Villa Costa 1		5.75	53.80	30'
				kms.	

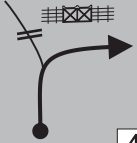
Distancia		Dirección	Información	Distancia Regresiva
Total	Parcial			
0.00	0.00	 1 5.75	 LPE 7/10  En poste de madera con cinta. GPS: S 26 51 029 W 65 42 448 ALT. 2023 1er. Auto 09:08 hs	26.90
0.13	0.13	 2 5.62		26.77
0.19	0.06	 3 5.56		26.71
0.39	0.20	 4 5.36		26.51
0.55	0.16	 5 5.20		26.35
0.63	0.08	 6 5.12		26.27

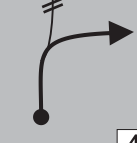
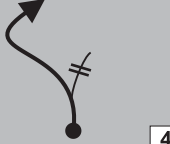
LPE	7	La Villa	Distancia	26.90	Etapa 2	Pag.
CH	8	El Rincón	kms.		Sector 13	26
Nro.	PRUEBA ESPECIAL		Kms.	Promedio	Tiempo Otorgado	
7/10	La Villa Costa 1		5.75	53.80 kms.	30'	

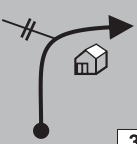
Distancia		Dirección	Información	Distancia Regresiva
Total	Parcial			
1.14	0.51	 7 4.61		25.76
1.29	0.15	 8 4.46		25.61
1.46	0.17	 9 4.29		25.44
1.53	0.07	 10 4.22		25.37
1.65	0.12	 11 4.10		25.25
1.87	0.22	 12 3.88		25.03

LPE	7	La Villa	Distancia	Etapa 2	Pag.
CH	8	El Rincón	26.90 kms.	Sector 13	27
Nro.	PRUEBA ESPECIAL		Kms.	Promedio	Tiempo Otorgado
7/10	La Villa Costa 1		5.75	53.80 kms.	30'

Distancia		Dirección	Información	Distancia Regresiva
Total	Parcial			
1.95	0.08			24.95
2.10	0.15			24.80
2.30	0.20			24.60
2.41	0.11			24.49
2.50	0.09			24.40
2.71	0.21			24.19

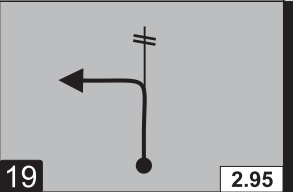
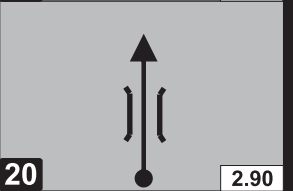
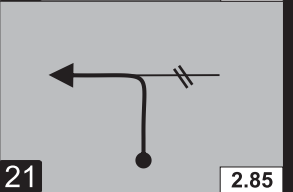
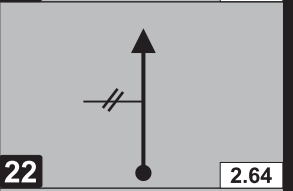
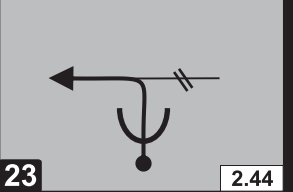
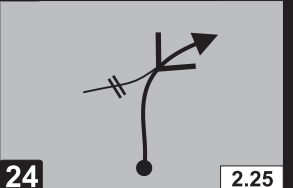

LPE	7	La Villa	Distancia	Etapa 2	Pag.
CH	8	El Rincón	26.90 kms.	Sector 13	28
Nro.	PRUEBA ESPECIAL		Kms.	Promedio	Tiempo Otorgado
7/10	La Villa Costa 1		5.75	53.80 kms.	30'

Distancia		Dirección	Información	Distancia Regresiva
Total	Parcial			
2.80	0.09			24.10
2.85	0.05			24.05
2.90	0.05		VEEDOR	24.00
3.11	0.21			23.79
3.31	0.20			23.59
3.50	0.19			23.40



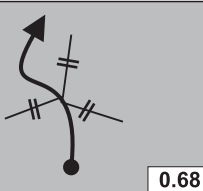
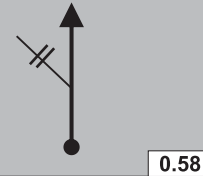
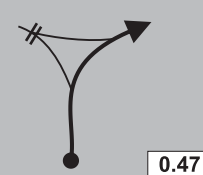
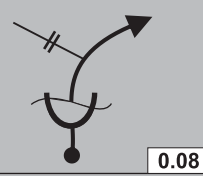
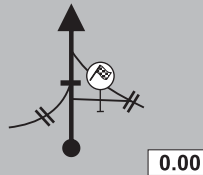

LPE	7	La Villa	Distancia	Etapa 2	Pag.
CH	8	El Rincón	26.90 kms.	Sector 13	29
Nro.	PRUEBA ESPECIAL		Kms.	Promedio	Tiempo Otorgado
7/10	La Villa Costa 1		5.75	53.80 kms.	30'

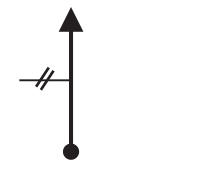
Distancia		Dirección	Información	Distancia Regresiva
Total	Parcial			
3.72	0.22			23.18
4.28	0.56			22.62
4.46	0.18			22.44
4.62	0.16			22.28
4.73	0.11			22.17
5.02	0.29			21.88



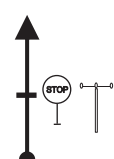

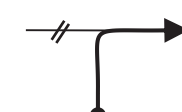
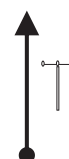

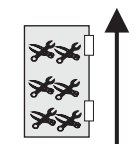
LPE	7	La Villa	Distancia	Etapa 2	Pag.
CH	8	El Rincón	26.90	Sector 13	30
			kms.		
Nro.	PRUEBA ESPECIAL		Kms.	Promedio	Tiempo Otorgado
7/10	La Villa Costa 1		5.75	53.80	30'
				kms.	

Distancia		Dirección	Información	Distancia Regresiva
Total	Parcial			
5.07	0.05	 31 0.68		21.83
5.17	0.10	 32 0.58		21.73
5.28	0.11	 33 0.47		21.62
5.67	0.39	 34 0.08		21.23
5.75	0.08	 35 0.00	 FPE 7/10  En cruce de calles. GPS: S 26 51 235 W 65 40 791 ALT. 2050	21.15
5.85	0.10	 36		21.05

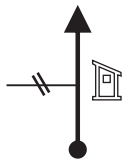

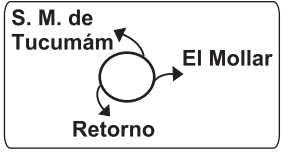

LPE	7	La Villa	Distancia	Etapa 2	Pag.
CH	8	El Rincón	26.90	Sector 13	31
			kms.		
Nro.	PRUEBA ESPECIAL		Kms.	Promedio	Tiempo Otorgado
7/10	La Villa Costa 1		5.75	53.80	30'
				kms.	

Distancia		Dirección	Información	Distancia Regresiva
Total	Parcial			
5.95	0.10	 37	 En poste de Madera.	20.95
5.98	0.03	 38		20.92
6.60	0.62	 39	LPE N° 1 Y 3	20.30
7.27	0.67	 40		19.63
7.30	0.03	 41	Por Rp N° 307	19.60
7.70	0.40	 42		19.20



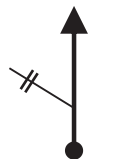

LPE	7	La Villa	Distancia	Etapa 2	Pag.
CH	8	El Rincón	26.90 kms.	Sector 13	32
Nro.	PRUEBA ESPECIAL		Kms.	Promedio	Tiempo Otorgado
7/10	La Villa Costa 1		5.75	53.80 kms.	30'

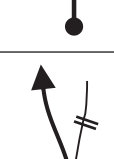
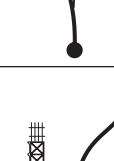
Distancia		Dirección	Información	Distancia Regresiva
Total	Parcial			
8.19	0.49	 43		18.71
10.25	2.06	 44	 A la Izquierda Ingreso a FPE 1 y 4	16.65
11.70	1.45	 45	<div style="border: 1px solid black; padding: 5px; display: inline-block;"> Punta de la Pirca </div>	15.20
15.75	4.05	 46		11.15
15.95	0.20	 47		10.95
17.10	1.15	 48	VERTEDERO	9.80







LPE	7	La Villa	Distancia	Etapa 2	Pag.
CH	8	El Rincón	26.90 kms.	Sector 13	33
Nro.	PRUEBA ESPECIAL		Kms.	Promedio	Tiempo Otorgado
7/10	La Villa Costa 1		5.75	53.80 kms.	30'

Distancia		Dirección	Información	Distancia Regresiva
Total	Parcial			
18.19	1.09	 49		8.71
18.53	0.34	 50	DEJA ASFALTO	8.37
18.82	0.29	 51	<div style="border: 1px solid black; padding: 5px; width: fit-content;"> <ul style="list-style-type: none"> ↑ El Potrerillo ↑ El Rincón ↑ Las Carreras </div>	8.08
19.56	0.74	 52	<div style="border: 1px solid black; padding: 5px; width: fit-content;"> Tafí del Valle </div>	7.34
20.58	1.02	 53		6.32
22.08	1.50	 54	<div style="border: 1px solid black; padding: 5px; width: fit-content;"> <i>i</i> En tranquera FPE 3 y 6 </div>	4.82

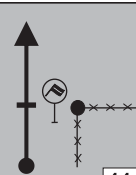



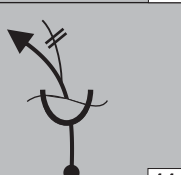
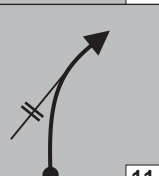
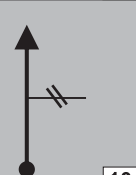

LPE	7	La Villa	Distancia	Etapa 2	Pag.
CH	8	El Rincón	26.90 kms.	Sector 13	34
Nro.	PRUEBA ESPECIAL		Kms.	Promedio	Tiempo Otorgado
7/10	La Villa Costa 1		5.75	53.80 kms.	30'

Distancia		Dirección	Información	Distancia Regresiva
Total	Parcial			
22.55	0.47	 55	<div style="border: 1px solid black; padding: 2px; display: inline-block;">El Potrerillo</div>	4.35
24.43	1.88	 56		2.47
24.99	0.56	 57		1.91
26.90	1.91	 58	 CH 8 En Cuanto deja camino Ancho. <div style="border: 1px solid black; padding: 2px; display: inline-block; font-size: small;">1er. Auto 09:38 hs.</div>	0.00

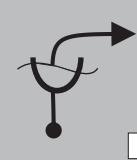

LPE	8	El Rincón	Distancia	Etapa 2	Pag.
CH	9	Casas Viejas	19.57	Sector 14	35
Nro. PRUEBA ESPECIAL			Promedio	Tiempo Otorgado	
8/11	El Rincón El Rincón		11.55	46.96	25'
			kms.	kms.	

Distancia		Dirección	Información	Distancia Regresiva
Total	Parcial			
0.00	0.00	 1 11.55	 LPE 8/11  En poste de esquinero de corral. GPS: S 26 57 701 W 65 45 845 ALT. 2210 1er. Auto 09:41 hs	19.57
0.10	0.10	 2 11.45		19.47
0.20	0.10	 3 11.35	Vado Natural	19.37
0.28	0.08	 4 11.27		19.29
0.71	0.43	 5 10.84		18.86
0.95	0.24	 6 10.60		18.62





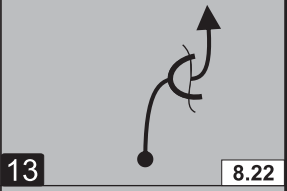
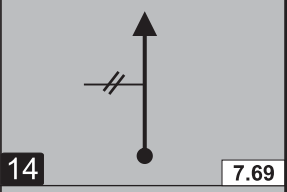
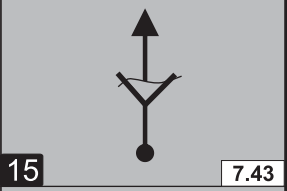
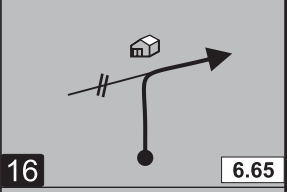
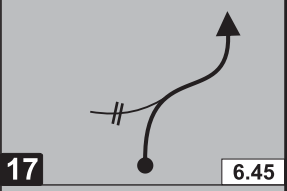
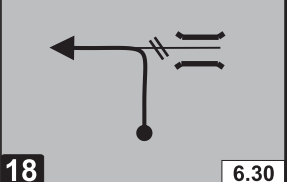

LPE	8	El Rincón	Distancia	Etapa 2	Pag.
CH	9	Casas Viejas	19.57	Sector 14	36
			kms.		
Nro.	PRUEBA ESPECIAL		Kms.	Promedio	Tiempo Otorgado
8/11	El Rincón El Rincón		11.55	46.96	25'
			kms.		

Distancia		Dirección	Información	Distancia Regresiva
Total	Parcial			
1.42	0.47	 7 10.13		18.15
2.12	0.70	 8 9.43	Vertiente	17.45
2.60	0.48	 9 8.95	Vado Natural	16.97
2.64	0.04	 10 8.91		16.93
3.00	0.36	 11 8.55	Zanja de Río 	16.57
3.11	0.11	 12 8.44		16.46

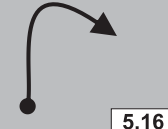
LPE	8	El Rincón	Distancia	Etapa 2	Pag.
CH	9	Casas Viejas	19.57	Sector 14	37
			kms.		
Nro.	PRUEBA ESPECIAL		Kms.	Promedio	Tiempo Otorgado
8/11	El Rincón El Rincón		11.55	46.96	25'
			kms.		

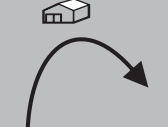
Distancia		Dirección	Información	Distancia Regresiva
Total	Parcial			
3.33	0.22			16.24
3.86	0.53			15.71
4.12	0.26			15.45
4.90	0.78			14.67
5.10	0.20			14.47
5.25	0.15		 Empalma con PE 3 y 6	14.32



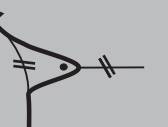





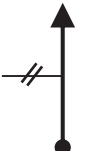

LPE	8	El Rincón	Distancia	Etapa 2	Pag.
CH	9	Casas Viejas	19.57	Sector 14	38
			kms.		
Nro.	PRUEBA ESPECIAL		Kms.	Promedio	Tiempo Otorgado
8/11	El Rincón El Rincón		11.55	46.96	25'
			kms.		

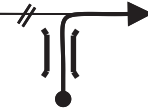
Distancia		Dirección	Información	Distancia Regresiva
Total	Parcial			
6.39	1.14	 19 5.16	Curva Angosta  Comienza a costear Cerro	13.18
6.88	0.49	 20 4.67	Mirador EL CONDOR	12.69
9.00	2.12	 21 2.55	El Rincón	10.57
10.70	1.70	 22 0.85		8.87
11.08	0.38	 23 0.47		8.49
11.53	0.45	 24 0.02	Chicana N° 1 Fuera del Camino Por detrás de Tacho	8.04

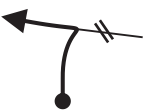
LPE	8	El Rincón	Distancia	Etapa 2	Pag.
CH	9	Casas Viejas	19.57 kms.	Sector 14	39
Nro.	PRUEBA ESPECIAL		Kms.	Promedio	Tiempo Otorgado
8/11	El Rincón El Rincón		11.55	46.96 kms.	25'



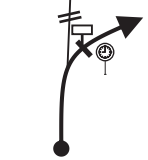



Distancia		Dirección	Información	Distancia Regresiva
Total	Parcial			
11.55	0.02		 En cartel Ruta Provincial N°355 GPS: S 26 57 773 W 65 45 910 ALT. 2214	8.02
11.75	0.20		 Antes de Cruce con LPE N° 8 y 11.	7.82
13.65	1.90		Zona Urbana	5.92
13.72	0.07			5.85
15.15	1.43			4.42
16.57	1.42		 FPE 3 y 6	3.00

LPE	8	El Rincón	Distancia	Etapa 2	Pag.
CH	9	Casas Viejas	19.57 kms.	Sector 14	40
Nro.	PRUEBA ESPECIAL		Kms.	Promedio	Tiempo Otorgado
8/11	El Rincón El Rincón		11.55	46.96 kms.	25'



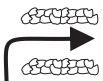

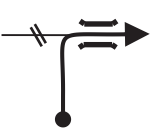
Distancia		Dirección	Información	Distancia Regresiva
Total	Parcial			
17.14	0.57	 31		2.43
18.08	0.94	 32	Por Adoquines	1.49
18.75	0.67	 33	Por Asfalto 	0.82
19.02	0.27	 34	Por Rp N°325 	0.55
19.47	0.45	 35		0.10
19.57	0.10	 36	 CH 9 Frente a Cartel de COMUNA INDÍGENA CASAS VIEJAS  1er. Auto 10:06 hs.	0.00

LPE	9	Casas Viejas	Distancia	Etapa 2	Pag.
CH	9A	Flexi Service - Ingreso	12.85 kms.	Sector 15	41
Nro.	PRUEBA ESPECIAL		Kms.	Promedio	Tiempo Otorgado
9/12	Casas Viejas San Cayetano		9.05	38.55 kms.	20'

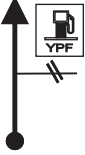

Se repite ídem a páginas 9, 10, 11 y 12 (hasta figura 19).

Distancia		Dirección	Información	Distancia Regresiva
Total	Parcial			
9.24	0.19	 20	 Frente a casa con pirca	3.61
9.29	0.05	 21		3.56
9.66	0.37	 22		3.19
9.78	0.12	 23		3.07
10.01	0.23	 24	Por Rn N°325 	2.84

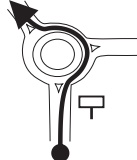
LPE	9	Casas Viejas	Distancia	Etapa 2	Pag.
CH	9A	Flexi Service - Ingreso	12.85 kms.	Sector 15	42
Nro.	PRUEBA ESPECIAL		Kms.	Promedio	Tiempo Otorgado
9/12	Casas Viejas San Cayetano		9.05	38.55 kms.	20'

Distancia		Dirección	Información	Distancia Regresiva
Total	Parcial			
10.43	0.42	 25		2.42
10.71	0.28	 26		2.14
10.89	0.18	 27	Por Av. Gob. Critto	1.96
11.45	0.56	 28		1.40
11.75	0.30	 29		1.10
12.19	0.44	 30	<div style="border: 1px solid black; padding: 5px; width: fit-content;"> S. M. de Tucumán → El Mollar → ← Amaicha </div>	0.66

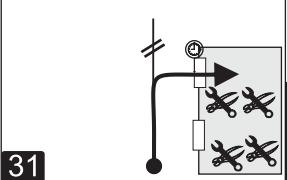
LPE	9	Casas Viejas	Distancia	Etapa 2	Pag.
CH	9A	Flexi Service - Ingreso	12.85 kms.	Sector 15	43
Nro.	PRUEBA ESPECIAL		Kms.	Promedio	Tiempo Otorgado
9/12	Casas Viejas San Cayetano		9.05	38.55 kms.	20'

Distancia		Dirección	Información	Distancia Regresiva
Total	Parcial			
12.85	0.66		 CH 9A Ingreso - Parque de Service Complejo Deportivo Democracia Deja Rp N°307 GPS: S 26 51 327 W 65 41 589 ALT. 1979	0.00

CH	9D	Parque de Servicio - Salida	Distancia	Etapa 2	Pag.
CH	10	La Villa	2.92 kms.	Sector 17	44
Nro.	PRUEBA ESPECIAL		Kms.	Promedio	Tiempo Otorgado
	ENLACE			17.52 kms.	10'

Se repite ídem a páginas 23 y 24..

LPE	10	La Villa	Distancia	Etapa 2	Pag.
CH	11	El Rincón	26.90 kms.	Sector 18	
Nro.	PRUEBA ESPECIAL		Kms.	Promedio	Tiempo Otorgado
7/10	La Villa Costa 1	5.75	53.80 kms.		30'

Se repite ídem a páginas 25, 26, 27, 28, 29, 30, 31, 32, 33 y 34.

LPE	11	El Rincón	Distancia	Etapa 2	Pag.
CH	12	Casas Viejas	19.57 kms.	Sector 19	
Nro.	PRUEBA ESPECIAL		Kms.	Promedio	Tiempo Otorgado
8/11	El Rincón El Rincón	11.55	46.96 kms.		25'

Se repite ídem a páginas 35, 36, 37, 38, 39 y 40.

LPE	12	Casas Viejas	Distancia	Etapa 2	Pag.
CH	12A	Parque Cerrado Final - Ingreso	12.85 kms.	Sector 20	
Nro.	PRUEBA ESPECIAL		Kms.	Promedio	Tiempo Otorgado
9/12	Casas Viejas San Cayetano	9.05	38.55 kms.		20'

Se repite ídem a páginas 9, 10, 11, 12 (hasta figura 19), 41, 42 y 43.